

# About CHINT



CHINT, a leading global provider of smart energy solutions.

Founded in 1984, CHINT is a leading global provider of smart energy solutions. It is actively deploying “4+1” industrial sectors including smart electrics, green energy, industrial control and automation, smart home and incubator, forming an integrated whole industry chain of “power generation, storage, transmission, substation, distribution, sales and consumption”.

It boasts an extensive business network across over 140 countries and regions as well as more than 30,000 employees and an annual sales revenue of over USD 16 billion. CHINT has been ranking among China’s Top 500 companies for 18 consecutive years. Its subsidiary, CHINT Electrics is the first company in China with low-voltage electrics as its main business getting listed on the A-share market as one of the Top 50 Asian listed companies.

To comply with the trend of integrated development of modern energy, intelligent manufacturing and digital technology, CHINT has adopted “One Cloud & Two Nets” as the business strategy. CHINT Cloud fulfills digital application and services in both internal and external as the platform of intelligent technology and data application. Based on the Industrial Internet of Things (IIoT), CHINT built an intelligent manufacturing system and realizes intelligent application in electrical industry. Relying on the Energy Internet of Things (EIoT), CHINT built its smart energy system and develops the regional EIoT mode.

Focusing on energy system of supply, storage, transmission, distribution and consumption. CHINT has core businesses in clean energy, energy distribution, big data and energy value-added services. Furthermore, CHINT’s pillar businesses include photovoltaic equipment, energy storage, power transmission & distribution, low-voltage apparatuses, intelligent terminals, software development and control automation. With developing into a platform-based enterprise, CHINT provides a package of energy solutions for public institutions, industrial & commercial users and end users, by building a regional smart energy operation ecosphere.

# Global Footprint



**140**  
Countries

**2300+**  
Distributors

**30+**  
Overseas Subsidiaries

**20+**  
Logistics Centers

**4**  
R&D Centers

**13**  
Manufacturing Bases

# Global Capacity Layout

The industrial manufacturing bases are mainly located in Wenzhou, Hangzhou, Shanghai, Jiaying and Xianyang. Additionally, CHINT has set up factories in Thailand, Egypt, Singapore, Vietnam, Malaysia, etc.



Egypt Production Base



Vietnam Production Base



Malaysia Production Base



Thailand Solar Power Production Base



Singapore Complete Electric Equipment Production Base



Shanghai Production Base



Hangzhou Production Base



Wenzhou Production Base



Jiaying Production Base



Xianyang Production Base

## Go CHINT APP

An essential mobile digital hub for CHINT's customers. You can easily find the latest products, information, events, news and training courses you need.

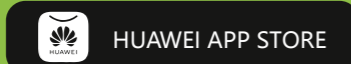

Scan the QR Code or search for "Go CHINT" on IOS APP store, Google play and Huawei APP store.

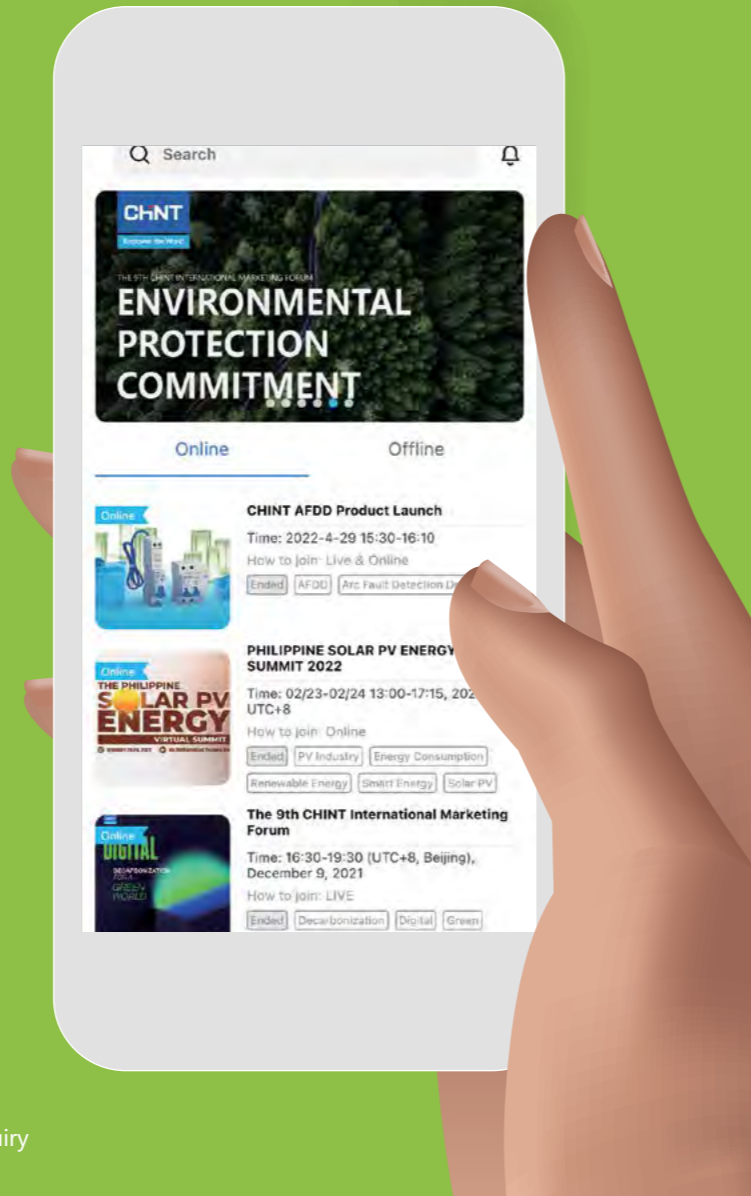

### EVENT MODULE

Technical community

- Online and offline event
- One-click registration
- Live streaming & playback



### USER CENTER

Social networking

- Selection of language
- Quick access to personal history information
- Social sharing



### TRAINING MODULE

Online courses

- Graded learning courses
- After-training exercises
- Interactive Community
- Certificates and Medals



### PRODUCT MODULE

Mini library

- Products information and catalogue download
- AR scan recognition
- Product selection & price inquiry

## Intelligent Manufacturing

Creating Digital Solutions with CHINT



## Index

Circuit Breakers	7
Miniature Circuit Breakers	7
Moulded Case Circuit Breakers	18
Air Circuit Breakers	29
Earth Leakage	31
Surge Arrestors	33
Contactors	35
Thermal Overload Relays	45
Starters	47
Push Buttons, Pilot Lights and Indicators	51
VSD and Soft Starters	55
Isolators	57
Changeover Switches	60
Relays	63
Current Transformers	67
Voltage Transformers	68
AVR	69
Travel Switches	70
Float Switches	73
Terminals	73
Fuses	75
Meters	76
Switches and Sockets	77
Distribution Boxes and Enclosures	79
Photovoltaic Devices	82

Prices exclude VAT. Prices subject to change without notice. E&OE



Dependable performance,  
Safe choice



## Circuit Breakers

### Miniature Circuit Breakers

3KA MCB 1-63A	Product Code	Item Description	Price
	EBC-1P-01A-3KA	3kA 1P 1A Circuit Breaker C-Curve	R67.67
	EBC-1P-02A-3KA	3kA 1P 2A Circuit Breaker C-Curve	R67.67
	EBC-1P-03A-3KA	3kA 1P 3A Circuit Breaker C-Curve	R67.67
	EBC-1P-04A-3KA	3kA 1P 4A Circuit Breaker C-Curve	R67.67
	EBC-1P-06A-3KA	3kA 1P 6A Circuit Breaker C-Curve	R67.67
	EBC-1P-10A-3KA	3kA 1P 10A Circuit Breaker C-Curve	R55.90
	EBC-1P-16A-3KA	3kA 1P 16A Circuit Breaker C-Curve	R55.90
	EBC-1P-20A-3KA	3kA 1P 20A Circuit Breaker C-Curve	R55.90
	EBC-1P-25A-3KA	3kA 1P 25A Circuit Breaker C-Curve	R55.90
	EBC-1P-32A-3KA	3kA 1P 32A Circuit Breaker C-Curve	R62.77
	EBC-1P-40A-3KA	3kA 1P 40A Circuit Breaker C-Curve	R62.77
	EBC-1P-50A-3KA	3kA 1P 50A Circuit Breaker C-Curve	R67.67
	EBC-1P-63A-3KA	3kA 1P 63A Circuit Breaker C-Curve	R67.67



### 3KA MCB 1-63A



Product Code	Item Description	Price
EBC-2P-01A-3KA	3kA 2P 1A Circuit Breaker C-Curve	R181.35
EBC-2P-02A-3KA	3kA 2P 2A Circuit Breaker C-Curve	R181.35
EBC-2P-03A-3KA	3kA 2P 3A Circuit Breaker C-Curve	R181.35
EBC-2P-04A-3KA	3kA 2P 4A Circuit Breaker C-Curve	R181.35
EBC-2P-06A-3KA	3kA 2P 6A Circuit Breaker C-Curve	R173.72
EBC-2P-10A-3KA	3kA 2P 10A Circuit Breaker C-Curve	R167.31
EBC-2P-16A-3KA	3kA 2P 16A Circuit Breaker C-Curve	R167.31
EBC-2P-20A-3KA	3kA 2P 20A Circuit Breaker C-Curve	R167.31
EBC-2P-25A-3KA	3kA 2P 25A Circuit Breaker C-Curve	R167.31
EBC-2P-32A-3KA	3kA 2P 32A Circuit Breaker C-Curve	R173.72
EBC-2P-40A-3KA	3kA 2P 40A Circuit Breaker C-Curve	R173.72
EBC-2P-50A-3KA	3kA 2P 50A Circuit Breaker C-Curve	R181.35
EBC-2P-63A-3KA	3kA 2P 63A Circuit Breaker C-Curve	R152.26



EBC-3P-01A-3KA	3kA 3P 1A Circuit Breaker C-Curve	R271.15
EBC-3P-02A-3KA	3kA 3P 2A Circuit Breaker C-Curve	R271.15
EBC-3P-03A-3KA	3kA 3P 3A Circuit Breaker C-Curve	R271.15
EBC-3P-04A-3KA	3kA 3P 4A Circuit Breaker C-Curve	R271.15
EBC-3P-06A-3KA	3kA 3P 6A Circuit Breaker C-Curve	R258.18
EBC-3P-10A-3KA	3kA 3P 10A Circuit Breaker C-Curve	R248.42
EBC-3P-16A-3KA	3kA 3P 16A Circuit Breaker C-Curve	R248.42
EBC-3P-20A-3KA	3kA 3P 20A Circuit Breaker C-Curve	R248.42
EBC-3P-25A-3KA	3kA 3P 25A Circuit Breaker C-Curve	R248.42
EBC-3P-32A-3KA	3kA 3P 32A Circuit Breaker C-Curve	R258.18
EBC-3P-40A-3KA	3kA 3P 40A Circuit Breaker C-Curve	R258.18
EBC-3P-50A-3KA	3kA 3P 50A Circuit Breaker C-Curve	R287.28
EBC-3P-63A-3KA	3kA 3P 63A Circuit Breaker C-Curve	R287.28

### 6KA MCB 1-63A (Energy Limiting: class 3)



Product Code	Item Description	Price
NB1-63-1P-C01-06	6kA 1P 1A Circuit Breaker C-Curve	R152.18
NB1-63-1P-C02-06	6kA 1P 2A Circuit Breaker C-Curve	R144.57
NB1-63-1P-C03-06	6kA 1P 3A Circuit Breaker C-Curve	R144.57
NB1-63-1P-C04-06	6kA 1P 4A Circuit Breaker C-Curve	R144.57
NB1-63-1P-C06-06	6kA 1P 6A Circuit Breaker C-Curve	R144.57
NB1-63-1P-C10-06	6kA 1P 10A Circuit Breaker C-Curve	R146.70
NB1-63-1P-C16-06	6kA 1P 16A Circuit Breaker C-Curve	R146.70
NB1-63-1P-C20-06	6kA 1P 20A Circuit Breaker C-Curve	R146.70
NB1-63-1P-C25-06	6kA 1P 25A Circuit Breaker C-Curve	R146.70
NB1-63-1P-C32-06	6kA 1P 32A Circuit Breaker C-Curve	R146.70
NB1-63-1P-C40-06	6kA 1P 40A Circuit Breaker C-Curve	R146.70
NB1-63-1P-C50-06	6kA 1P 50A Circuit Breaker C-Curve	R152.18
NB1-63-1P-C63-06	6kA 1P 63A Circuit Breaker C-Curve	R152.18



NB1-63-2P-C01-06	6kA 2P 1A Circuit Breaker C-Curve	R306.39
NB1-63-2P-C02-06	6kA 2P 2A Circuit Breaker C-Curve	R306.39
NB1-63-2P-C03-06	6kA 2P 3A Circuit Breaker C-Curve	R306.39
NB1-63-2P-C04-06	6kA 2P 4A Circuit Breaker C-Curve	R306.39
NB1-63-2P-C06-06	6kA 2P 6A Circuit Breaker C-Curve	R306.39
NB1-63-2P-C10-06	6kA 2P 10A Circuit Breaker C-Curve	R288.39
NB1-63-2P-C16-06	6kA 2P 16A Circuit Breaker C-Curve	R288.39
NB1-63-2P-C20-06	6kA 2P 20A Circuit Breaker C-Curve	R288.39
NB1-63-2P-C25-06	6kA 2P 25A Circuit Breaker C-Curve	R288.39
NB1-63-2P-C32-06	6kA 2P 32A Circuit Breaker C-Curve	R288.39
NB1-63-2P-C40-06	6kA 2P 40A Circuit Breaker C-Curve	R288.39
NB1-63-2P-C50-06	6kA 2P 50A Circuit Breaker C-Curve	R316.94
NB1-63-2P-C63-06	6kA 2P 63A Circuit Breaker C-Curve	R316.94

**6KA MCB 1-63A**  
(Energy Limiting: class 3)



Product Code	Item Description	Price
NB1-63-3P-C01-06	6kA 3P 1A Circuit Breaker C-Curve	R463.96
NB1-63-3P-C02-06	6kA 3P 2A Circuit Breaker C-Curve	R463.96
NB1-63-3P-C03-06	6kA 3P 3A Circuit Breaker C-Curve	R463.96
NB1-63-3P-C04-06	6kA 3P 4A Circuit Breaker C-Curve	R463.96
NB1-63-3P-C06-06	6kA 3P 6A Circuit Breaker C-Curve	R463.96
NB1-63-3P-C10-06	6kA 3P 10A Circuit Breaker C-Curve	R433.96
NB1-63-3P-C16-06	6kA 3P 16A Circuit Breaker C-Curve	R433.96
NB1-63-3P-C20-06	6kA 3P 20A Circuit Breaker C-Curve	R433.96
NB1-63-3P-C25-06	6kA 3P 25A Circuit Breaker C-Curve	R433.96
NB1-63-3P-C32-06	6kA 3P 32A Circuit Breaker C-Curve	R433.96
NB1-63-3P-C40-06	6kA 3P 40A Circuit Breaker C-Curve	R433.96
NB1-63-3P-C50-06	6kA 3P 50A Circuit Breaker C-Curve	R490.67
NB1-63-3P-C63-06	6kA 3P 63A Circuit Breaker C-Curve	R490.67



NB1-63-4P-C2-06	6kA 4P 2A Circuit Breaker C-Curve	R642.24
NB1-63-4P-C16-06	6kA 4P 16A Circuit Breaker C-Curve	R585.29
NB1-63-4P-C20-06	6kA 4P 20A Circuit Breaker C-Curve	R585.29
NB1-63-4P-C25-06	6kA 4P 25A Circuit Breaker C-Curve	R585.29
NB1-63-4P-C32-06	6kA 4P 32A Circuit Breaker C-Curve	R585.29
NB1-63-4P-C50-06	6kA 4P 50A Circuit Breaker C-Curve	R642.24
NB1-63-4P-C63-06	6kA 4P 63A Circuit Breaker C-Curve	R642.24

**6KA MCB 1-63A**  
(Energy Limiting: class 3)



Product Code	Item Description	Price
NB1-63-1P-D01-06	6kA 1P 1A Circuit Breaker D-Curve	R175.24
NB1-63-1P-D02-06	6kA 1P 2A Circuit Breaker D-Curve	R175.24
NB1-63-1P-D03-06	6kA 1P 3A Circuit Breaker D-Curve	R175.24
NB1-63-1P-D04-06	6kA 1P 4A Circuit Breaker D-Curve	R175.24
NB1-63-1P-D06-06	6kA 1P 6A Circuit Breaker D-Curve	R160.45
NB1-63-1P-D10-06	6kA 1P 10A Circuit Breaker D-Curve	R160.45
NB1-63-1P-D16-06	6kA 1P 16A Circuit Breaker D-Curve	R160.45
NB1-63-1P-D20-06	6kA 1P 20A Circuit Breaker D-Curve	R160.45
NB1-63-1P-D25-06	6kA 1P 25A Circuit Breaker D-Curve	R160.45
NB1-63-1P-D32-06	6kA 1P 32A Circuit Breaker D-Curve	R160.45
NB1-63-1P-D40-06	6kA 1P 40A Circuit Breaker D-Curve	R160.45
NB1-63-1P-D50-06	6kA 1P 50A Circuit Breaker D-Curve	R175.24
NB1-63-1P-D63-06	6kA 1P 63A Circuit Breaker D-Curve	R175.24



NB1-63-2P-D01-06	6kA 2P 1A Circuit Breaker D-Curve	R387.64
NB1-63-2P-D02-06	6kA 2P 2A Circuit Breaker D-Curve	R387.64
NB1-63-2P-D04-06	6kA 2P 4A Circuit Breaker D-Curve	R387.64
NB1-63-2P-D06-06	6kA 2P 6A Circuit Breaker D-Curve	R355.98
NB1-63-2P-D10-06	6kA 2P 10A Circuit Breaker D-Curve	R355.98
NB1-63-2P-D16-06	6kA 2P 16A Circuit Breaker D-Curve	R355.98
NB1-63-2P-D20-06	6kA 2P 20A Circuit Breaker D-Curve	R355.98
NB1-63-2P-D25-06	6kA 2P 25A Circuit Breaker D-Curve	R355.98
NB1-63-2P-D32-06	6kA 2P 32A Circuit Breaker D-Curve	R355.98
NB1-63-2P-D40-06	6kA 2P 40A Circuit Breaker D-Curve	R355.98
NB1-63-2P-D50-06	6kA 2P 50A Circuit Breaker D-Curve	R387.64
NB1-63-2P-D63-06	6kA 2P 63A Circuit Breaker D-Curve	R387.64

**6KA MCB 1-63A**  
(Energy Limiting: class 3)



Product Code	Item Description	Price
NB1-63-3P-D01-06	6kA 3P 1A Circuit Breaker D-Curve	R555.84
NB1-63-3P-D02-06	6kA 3P 2A Circuit Breaker D-Curve	R555.84
NB1-63-3P-D03-06	6kA 3P 3A Circuit Breaker D-Curve	R555.84
NB1-63-3P-D04-06	6kA 3P 4A Circuit Breaker D-Curve	R555.84
NB1-63-3P-D06-06	6kA 3P 6A Circuit Breaker D-Curve	R506.22
NB1-63-3P-D10-06	6kA 3P 10A Circuit Breaker D-Curve	R506.22
NB1-63-3P-D16-06	6kA 3P 16A Circuit Breaker D-Curve	R506.22
NB1-63-3P-D20-06	6kA 3P 20A Circuit Breaker D-Curve	R506.22
NB1-63-3P-D25-06	6kA 3P 25A Circuit Breaker D-Curve	R506.22
NB1-63-3P-D32-06	6kA 3P 32A Circuit Breaker D-Curve	R506.22
NB1-63-3P-D40-06	6kA 3P 40A Circuit Breaker D-Curve	R506.22
NB1-63-3P-D50-06	6kA 3P 50A Circuit Breaker D-Curve	R555.84
NB1-63-3P-D63-06	6kA 3P 63A Circuit Breaker D-Curve	R555.84

**10KA MCB 1-63A**  
(Energy limiting: class 3)



Product Code	Item Description	Price
NB1-63H-1P-C01-10	10kA 1P 1A Circuit Breaker C-Curve	R168.86
NB1-63H-1P-C02-10	10kA 1P 2A Circuit Breaker C-Curve	R168.86
NB1-63H-1P-C04-10	10kA 1P 4A Circuit Breaker C-Curve	R168.86
NB1-63H-1P-C06-10	10kA 1P 6A Circuit Breaker C-Curve	R168.86
NB1-63H-1P-C10-10	10kA 1P 10A Circuit Breaker C-Curve	R156.20
NB1-63H-1P-C16-10	10kA 1P 16A Circuit Breaker C-Curve	R156.20
NB1-63H-1P-C20-10	10kA 1P 20A Circuit Breaker C-Curve	R156.20
NB1-63H-1P-C25-10	10kA 1P 25A Circuit Breaker C-Curve	R156.20
NB1-63H-1P-C32-10	10kA 1P 32A Circuit Breaker C-Curve	R156.20
NB1-63H-1P-C40-10	10kA 1P 40A Circuit Breaker C-Curve	R156.20
NB1-63H-1P-C50-10	10kA 1P 50A Circuit Breaker C-Curve	R168.86
NB1-63H-1P-C63-10	10kA 1P 63A Circuit Breaker C-Curve	R168.86





NB1-63H-2P-C10-10	10kA 2P 10A Circuit Breaker C-Curve	R348.04
NB1-63H-2P-C16-10	10kA 2P 16A Circuit Breaker C-Curve	R348.04
NB1-63H-2P-C25-10	10kA 2P 25A Circuit Breaker C-Curve	R321.14
NB1-63H-2P-C32-10	10kA 2P 32A Circuit Breaker C-Curve	R321.14
NB1-63H-2P-C40-10	10kA 2P 40A Circuit Breaker C-Curve	R321.14
NB1-63H-2P-C50-10	10kA 2P 50A Circuit Breaker C-Curve	R357.06
NB1-63H-2P-C63-10	10kA 2P 63A Circuit Breaker C-Curve	R357.06





NB1-63H-3P-C06-10	10kA 3P 6A Circuit Breaker C-Curve	R483.01
NB1-63H-3P-C10-10	10kA 3P 10A Circuit Breaker C-Curve	R483.01
NB1-63H-3P-C16-10	10kA 3P 16A Circuit Breaker C-Curve	R483.01
NB1-63H-3P-C20-10	10kA 3P 20A Circuit Breaker C-Curve	R483.01
NB1-63H-3P-C25-10	10kA 3P 25A Circuit Breaker C-Curve	R483.01
NB1-63H-3P-C32-10	10kA 3P 32A Circuit Breaker C-Curve	R483.01
NB1-63H-3P-C40-10	10kA 3P 40A Circuit Breaker C-Curve	R483.01
NB1-63H-3P-C50-10	10kA 3P 50A Circuit Breaker C-Curve	R533.68
NB1-63H-3P-C63-10	10kA 3P 63A Circuit Breaker C-Curve	R533.68

DC MCB 1-63A	Product Code	Item Description	Price
	NB1-63-1P-C03-DC	10kA 1P 3A Circuit Breaker DC125V	R229.03
	NB1-63-1P-C06-DC	10kA 1P 6A Circuit Breaker DC125V	R229.03
	NB1-63-1P-C10-DC	10kA 1P 10A Circuit Breaker DC125V	R218.49
	NB1-63-1P-C16-DC	10kA 1P 16A Circuit Breaker DC125V	R218.49
	NB1-63-1P-C20-DC	10kA 1P 20A Circuit Breaker DC125V	R218.49
	NB1-63-1P-C25-DC	10kA 1P 25A Circuit Breaker DC125V	R218.49
	NB1-63-1P-C32-DC	10kA 1P 32A Circuit Breaker DC125V	R218.49
	NB1-63-1P-C50-DC	10kA 1P 50A Circuit Breaker DC125V	R238.53
	NB1-63-1P-C63-DC	10kA 1P 63A Circuit Breaker DC125V	R238.53

	NB1-63-2P-C02-DC	10kA 2P 2A Circuit Breaker DC125V	R370.77
	NB1-63-2P-C03-DC	10kA 2P 3A Circuit Breaker DC125V	R370.77
	NB1-63-2P-C04-DC	10kA 2P 4A Circuit Breaker DC125V	R370.77
	NB1-63-2P-C06-DC	10kA 2P 6A Circuit Breaker DC125V	R370.77
	NB1-63-2P-C10-DC	10kA 2P 10A Circuit Breaker DC125V	R347.56
	NB1-63-2P-C16-DC	10kA 2P 16A Circuit Breaker DC125V	R347.56
	NB1-63-2P-C20-DC	10kA 2P 20A Circuit Breaker DC125V	R347.56
	NB1-63-2P-C25-DC	10kA 2P 25A Circuit Breaker DC125V	R347.56
	NB1-63-2P-C40-DC	10kA 2P 40A Circuit Breaker DC125V	R347.56
	NB1-63-2P-C50-DC	10kA 2P 50A Circuit Breaker DC125V	R399.31
	NB1-63-2P-C63-DC	10kA 2P 63A Circuit Breaker DC125V	R399.31

Compact MCB 10-40A	Product Code	Item Description	Price
	NBH8-40-1P+N-C10	4.5kA 1P+N 10A Compact Circuit Breaker C-Curve	R207.14
	NBH8-40-1P+N-C16	4.5kA 1P+N 16A Compact Circuit Breaker C-Curve	R207.14
	NBH8-40-1P+N-C20	4.5kA 1P+N 20A Compact Circuit Breaker C-Curve	R207.14
	NBH8-40-1P+N-C25	4.5kA 1P+N 25A Compact Circuit Breaker C-Curve	R207.14
	NBH8-40-1P+N-C32	4.5kA 1P+N 32A Compact Circuit Breaker C-Curve	R226.20
	NBH8-40-1P+N-C40	4.5kA 1P+N 40A Compact Circuit Breaker C-Curve	R226.20

6KA MCB 80-125A	Product Code	Item Description	Price
	DZ158-1P-C080-06	6kA 1P 80A Circuit Breaker C-Curve	R222.70
	DZ158-1P-C100-06	6kA 1P 100A Circuit Breaker C-Curve	R247.04
	DZ158-1P-C125-06	6kA 1P 125A Circuit Breaker C-Curve	R342.04

	DZ158-2P-C080-06	6kA 2P 80A Circuit Breaker C-Curve	R470.02
	DZ158-2P-C100-06	6kA 2P 100A Circuit Breaker C-Curve	R479.14
	DZ158-2P-C125-06	6kA 2P 125A Circuit Breaker C-Curve	R614.30

	DZ158-3P-C080-06	6kA 3P 80A Circuit Breaker C-Curve	R635.06
	DZ158-3P-C100-06	6kA 3P 100A Circuit Breaker C-Curve	R705.75
	DZ158-3P-C125-06	6kA 3P 125A Circuit Breaker C-Curve	R858.44

	DZ158-4P-C080-06	6kA 4P 80A Circuit Breaker C-Curve	R920.99
	DZ158-4P-C100-06	6kA 4P 100A Circuit Breaker C-Curve	R963.77

6KA MCB 80-125A	Product Code	Item Description	Price
	DZ158-1P-D080-06	6kA 1P 80A Circuit Breaker D-Curve	R222.70
	DZ158-1P-D100-06	6kA 1P 100A Circuit Breaker D-Curve	R247.04
	NXB-1P-D125-06	6kA 1P 125A Circuit Breaker D-Curve	R346.83

	DZ158-2P-D080-06	6KA 2P 80A Circuit Breaker D-Curve	R480.94
	DZ158-2P-D100-06	6kA 2P 100A Circuit Breaker D-Curve	R488.62

	DZ158-3P-D080-06	6kA 3P 80A Circuit Breaker D-Curve	R635.06
	DZ158-3P-D100-06	6kA 3P 100A Circuit Breaker D-Curve	R705.75

10KA MCB 80-125A	Product Code	Item Description	Price
	DZ158H-1P-C080-10	10kA 1P 80A Circuit Breaker C-Curve	R264.95
	DZ158H-1P-C100-10	10kA 1P 100A Circuit Breaker C-Curve	R307.20
	DZ158H-1P-C125-10	10kA 1P 125A Circuit Breaker C-Curve	R371.13

	DZ158H-2P-C080-10	10kA 2P 80A Circuit Breaker C-Curve	R537.55
	DZ158H-2P-C100-10	10kA 2P 100A Circuit Breaker C-Curve	R547.10
	DZ158H-2P-C125-10	10kA 2P 125A Circuit Breaker C-Curve	R652.68

	DZ158H-3P-C080-10	10kA 3P 80A Circuit Breaker C-Curve	R669.01
	DZ158H-3P-C100-10	10kA 3P 100A Circuit Breaker C-Curve	R712.83
	DZ158H-3P-C125-10	10kA 3P 125A Circuit Breaker C-Curve	R861.81



	DZ158H-3P-D080-10	10kA 3P 80A Circuit Breaker D-Curve	R705.25
	DZ158H-3P-D100-10	10kA 3P 100A Circuit Breaker D-Curve	R738.67

MCB Accessories	Product Code	Item Description	Price
	ST-NB1-S9	NB1 Shunt Trip Clip On 230/400V	R216.66
	AUX-NB1-XF9	NB1 Side Mount Auxiliary Contact 1NO+1NC	R133.23
	UVR-NB1-V9	NB1 Side Mount Under Voltage Release 230V	R371.72
	TH35-7.5	Din Rail 1 Meter Length	R65.62
	P-BUSBAR-1P-63A	Pin Type Busbar 1P 63A (1 Meter)	R185.38
	P-BUSBAR-3P-63A	Pin Type Busbar 3P 63A (1 Meter)	R547.04





## Moulded Case Circuit Breakers

Fixed type MCCB	Product Code	Item Description	Price
	NM1-125S/3P-25A	25KA 25A 3P MCCB	R1 543.51
	NM1-125S/3P-32A	25KA 32A 3P MCCB	R1 543.51
	NM1-125S/3P-40A	25KA 40A 3P MCCB	R1 543.51
	NM1-125S/3P-50A	25KA 50A 3P MCCB	R1 543.51
	NM1-125S/3P-63A	25KA 63A 3P MCCB	R1 543.51
	NM1-125S/3P-80A	25KA 80A 3P MCCB	R1 543.51
	NM1-125S/3P-100A	25KA 100A 3P MCCB	R1 543.51
	NM1-125H/3P-63A	50KA 63A 3P MCCB	R1 840.26
	NM1-125H/3P-80A	50KA 80A 3P MCCB	R1 840.26
	NM1-125H/3P-100A	50KA 100A 3P MCCB	R1 840.26
	NM1-250S/3P-125A	25KA 125A 3P MCCB	R2 268.14
	NM1-250S/3P-150A	25KA 150A 3P MCCB	R2 268.14
	NM1-250S/3P-160A	25KA 160A 3P MCCB	R2 268.14
	NM1-250S/3P-175A	25KA 175A 3P MCCB	R2 268.14
	NM1-250S/3P-200A	25KA 200A 3P MCCB	R2 268.14
	NM1-250S/3P-225A	25KA 225A 3P MCCB	R2 268.14
	NM1-250S/3P-250A	25KA 250A 3P MCCB	R2 268.14
	NM1-250H/3P-125A	50KA 125A 3P MCCB	R2 519.27
	NM1-250H/3P-160A	50KA 160A 3P MCCB	R2 519.27
	NM1-250H/3P-200A	50KA 200A 3P MCCB	R2 519.27
	NM1-400S/3P-250A	35KA 250A 3P MCCB	R6 805.47
	NM1-400S/3P-315A	35KA 315A 3P MCCB	R6 805.47
	NM1-400S/3P-350A	35KA 350A 3P MCCB	R6 805.47
	NM1-400S/3P-400A	35KA 400A 3P MCCB	R6 805.47
	NM1-400H/3P-250A	50KA 250A 3P MCCB	R7 453.60
	NM1-400H/3P-400A	50KA 400A 3P MCCB	R7 453.60

Fixed type MCCB	Product Code	Item Description	Price
	NM1-630S/3P-450A	35KA 450A 3P MCCB	R9 780.95
	NM1-630S/3P-500A	35KA 500A 3P MCCB	R9 780.95
	NM1-630S/3P-630A	35KA 630A 3P MCCB	R9 780.95
	NM1-630H/3P-500A	50KA 500A 3P MCCB	R10 680.31
	NM1-630H/3P-630A	50KA 630A 3P MCCB	R10 680.31
	NM1-800H/3P-700A	60KA 700A 3P MCCB	R12 297.09
	NM1-800H/3P-800A	60KA 800A 3P MCCB	R12 297.09
	NM1-1250H/3P-1000A	65KA 1000A 3P MCCB	R33 364.58
	NM1-1250H/3P-1250A	65KA 1250A 3P MCCB	R33 364.58
	NM1-250H/4P-125A	50KA 125A 4P MCCB	R3 650.01
	NM1-250H/4P-160A	50KA 160A 4P MCCB	R3 650.01
	NM1-250H/4P-200A	50KA 200A 4P MCCB	R3 650.01
	NM1-250H/4P-250A	50KA 250A 4P MCCB	R3 650.01
	NM1-400S/4P-315A	35KA 315A 4P MCCB	R7 755.25
NM1 Accessories	Product Code	Item Description	Price
	AUX-NM1-125S-RH	Auxiliary Switch NM1-125S R/Hand	R240.29
	AUX-NM1-250S-RH	Auxiliary Switch NM1-250S R/Hand	R267.28
	AUX-NM1-250S-LH	Auxiliary Switch NM1-250S L/Hand	R267.28
	AUX-NM1-400S-RH	Auxiliary Switch NM1-400S R/Hand	R424.69
	AUX-NM1-400S-LH	Auxiliary Switch NM1-400S L/Hand	R424.69
	AUX-NM1-630S-RH	Auxiliary Switch NM1-630S R/Hand	R463.89
	AUX-NM1-630S-LH	Auxiliary Switch NM1-630S L/Hand	R463.89
	AUX-NM1-800S-RH	Auxiliary Switch NM1-800S R/Hand	R463.89
	AUX-NM1-1250H-RH	Auxiliary Switch NM1-1250-R/Hand	R682.99

NM1 Accessories	Product Code	Item Description	Price
	ST-NM1-125-LH-230V	Shunt Trip Release NM1-125-230V L/Hand	R508.13
	ST-NM1-125-LH-400V	Shunt Trip Release NM1-125-400V L/Hand	R546.32
	ST-NM1-250-LH-230V	Shunt Trip Release NM1-250-230V L/Hand	R508.13
	ST-NM1-250-LH-400V	Shunt Trip Release NM1-250-400V L/Hand	R546.32
	ST-NM1-400-LH-400V	Shunt Trip Release NM1-400-400V L/Hand	R1 152.12
	ST-NM1-630-LH-400V	Shunt Trip Release NM1-630-400V L/Hand	R1 213.62
	ST-NM1-800-LH-400V	Shunt Trip Release NM1-800-400V L/Hand	R1 213.62
	ST-NM1-1250-RH-400V	Shunt Trip Release NM1-1250-400V R/Hand	R1 820.46

	UVR-NM1-125 400V	Under Voltage Release NM1-125 400V	R1 365.36
	UVR-NM1-250 400V	Under Voltage Release NM1-250 400V	R1 375.56
	UVR-NM1-400 400V	Under Voltage Release NM1-400 400V	R2 338.15
	UVR-NM1-630 400V	Under Voltage Release NM1-630 400V	R2 338.15
	UVR-NM1-800 400V	Under voltage release NM1-800 400V	R2 338.15
	UVR-NM1-1250 230V	Under Voltage Release NM1-1250 230V	R2 470.82
	UVR-NM1-1250 400V	Under Voltage Release NM1-1250 400V	R2 470.82

NM1 Accessories	Product Code	Item Description	Price
	OH-NM1-125-300mm	Operating Handle NM1-125S-300mm	R798.11
	OH-NM1-250-300mm	Operating Handle NM1-250S-300mm	R894.08
	OH-NM1-400-300mm	Operating Handle NM1-400S-300mm	R1 069.33
	OH-NM1-630-300mm	Operating Handle NM1-630S-300mm	R1 203.08
	OH-NM1-800-300mm	Operating Handle NM1-800S-300mm	R1 245.67
	OH-NM1-1250-300mm	Operating Handle NM1-1250-300mm	R2 303.37

	MI-NM1-125	Mechanical interlock NM1-125/3P	R1 171.97
	MI-NM1-250	Mechanical Interlock NM1-250/3P	R1 403.40
	MI-NM1-400	Mechanical interlock NM1-400/3P	R1 644.44
	MI-NM1-630	Mechanical interlock NM1-630/3P	R1 995.09

	CU-NM1-125S6	Copper Connection Plate For NM1-125S	R286.88
	CU-NM1-250S6	Copper Connection Plate For NM1/NM8 250	R571.95
	CU-NM1-400S6	Copper Connection Plate For NM1-400	R1 130.99
	CU-NM1-630S6	Copper Connection Plate For NM1-630	R2 844.99

Fixed Type MCCB	Product Code	Item Description	Price
	NXM-125S/3P-32A	25KA 32A 3P MCCB	R1 603.46
	NXM-125S/3P-40A	25KA 40A 3P MCCB	R1 603.46
	NXM-125S/3P-50A	25KA 50A 3P MCCB	R1 603.46
	NXM-125S/3P-63A	25KA 63A 3P MCCB	R1 603.46
	NXM-125S/3P-80A	25KA 80A 3P MCCB	R1 603.46
	NXM-125S/3P-100A	25KA 100A 3P MCCB	R1 603.46
	NXM-125S/3P-125A	25KA 125A 3P MCCB	R1 603.46
	NXM-250S/3P-160A	36KA 160A 3P MCCB	R2 381.54
	NXM-250S/3P-180A	36KA 180A 3P MCCB	R2 381.54
	NXM-250S/3P-200A	36KA 200A 3P MCCB	R2 381.54
	NXM-250S/3P-225A	36KA 225A 3P MCCB	R2 381.54
	NXM-250S/3P-250A	36KA 250A 3P MCCB	R2 381.54
	NXM-400S/3P-315A	50KA 315A 3P MCCB	R7 145.74
	NXM-400S/3P-350A	50KA 350A 3P MCCB	R7 145.74
	NXM-400S/3P-400A	50KA 400A 3P MCCB	R7 145.74
	NXM-630S/3P-400A	50KA 400A 3P MCCB	R10 270.01
	NXM-630S/3P-500A	50KA 500A 3P MCCB	R10 270.01
	NXM-630S/3P-630A	50KA 630A 3P MCCB	R10 270.01
	NXM-800S/3P-800A	50KA 800A 3P MCCB	R12 911.94
	NXM-1250H/3P-1000A	70KA 1000A 3P MCCB	R35 392.60
	NXM-1250H/3P-1250A	70KA 1250A 3P MCCB	R35 392.60
	NXM-125H/4P 63A	50KA 63A 4P MCCB	R1 651.89
	NXM-125H/4P 100A	50KA 100A 4P MCCB	R1 651.89
	NXM-125H/4P 125A	50KA 125A 4P MCCB	R1 651.89
	NXM-250H/4P-160A	50KA 160A 4P MCCB	R2 951.25
	NXM-250H/4P 180A	50KA 180A 4P MCCB	R2 951.25
	NXM-250H/4P 200A	50KA 200A 4P MCCB	R2 951.25
	NXM-250H/4P 225A	50KA 225A 4P MCCB	R2 951.25
NXM-250H/4P 250A	50KA 250A 4P MCCB	R2 951.25	
NXM-400H/4P 315A	70KA 315A 4P MCCB	R7 377.86	
NXM-400H/4P 350A	70KA 350A 4P MCCB	R7 377.86	
NXM-400H/4P 400A	70KA 400A 4P MCCB	R7 377.86	
NXM-630H/4P 500A	70KA 500A 4P MCCB	R10 478.93	
NXM-630H/4P 630A	70KA 630A 4P MCCB	R10 478.93	

NXM Accessories	Product Code	Item Description	Price
	AUX-NXM-125	Auxiliary Contact NXM-125 R/Hand	R231.29
	AUX-NXM-250	Auxiliary Contact NXM-250 L/Hand	R231.29
	AUX-NXM-400/630	Auxiliary Contact NXM-400/630 L/Hand	R457.13
	AUX-NXM-800	Auxiliary Contact NXM-800 L/Hand	R465.31
	AUX-NXM-1250	Auxiliary Contact NXM-1250 L/Hand	R766.99
	ST-NXM-250 230V	Shunt Trip Release NXM-250 AC230V R/Hand	R509.28
	ST-NXM-250 400V	Shunt Trip Release NXM-250 AC400V R/Hand	R509.28
	ST-NXM-400/630 230V	Shunt Trip Release NXM-400/630 AC230V R/Hand	R1 156.45
	ST-NXM-400/630 400V	Shunt Trip Release NXM-400/630 AC400V R/Hand	R1 156.45
	ST-NXM-800 230V	Shunt Trip Release NXM-800 AC230V R/Hand	R1 272.01
	ST-NXM-800 400V	Shunt Trip Release NXM-800 AC400V R/Hand	R1 272.01
	ST-NXM-1250 230V	Shunt Trip Release NXM-1250 AC230V L/Hand	R2 486.25
	ST-NXM-1250 400V	Shunt Trip Release NXM-1250 AC400V L/Hand	R2 486.25
	UVR-NXM-125 230V	Under Voltage Release NXM-125 230V L/Hand	R1 101.40
	UVR-NXM-250 230V	Under Voltage Release NXM-250 230V R/Hand	R1 173.79
	UVR-NXM-400/630 230V	Under Voltage Release NXM-400/630 230V R/Hand	R2 486.25
	UVR-NXM-800 230V	Under Voltage Release NXM-800 230V L/Hand	R2 684.47
	UVR-NXM-1250 230V	Under Voltage Release NXM-1250 230V L/Hand	R5 589.16

NXM Accessories	Product Code	Item Description	Price
	CU-NXM-125	Copper Connection Plate for NXM-125	R275.10
	CU-NXM-250	Copper Connection Plate for NXM-250	R1 031.54
	CU-NXM-400/630	Copper Connection Plate for NXM-400/630	R1 527.88
	CU-NXM-800	Copper Connection Plate for NXM-800	R4 239.35
	CU-NXM-1250	Copper Connection Plate for NXM-1250 3P	R11 426.14
<p>Copper connection plate for NXM-125/250 consists of 2pcs CRV and 4pcs STR</p> <p>Copper connection plate for NXM-400/630/800 consists of 4pcs CRV and 2pcs STR</p>			
	OH-NXM-125-300mm	Operating Handle NXM-125-300mm	R847.95
	OH-NXM-250-300mm	Operating Handle NXM-250-300mm	R930.62
	OH-NXM-400/630-300mm	Operating Handle NXM-400/630-300mm	R1 272.01
	OH-NXM-800-300mm	Operating Handle NXM-800-300mm	R1 525.29
	OH-NXM-1250-300mm	Operating Handle NXM-1250-300mm	R2 034.74
	EM-NXM-250 230V	Electro Motor NXM-250 AC230/DC220	R6 514.20
	EM-NXM-400/630 230V	Electro Motor NXM-400/630 AC230/DC220	R12 059.50
	EM-NXM-800 230V	Electro Motor NXM-800 AC230/DC220	R13 463.61
	EM-NXM-1250 230V	Electro Motor NXM-1250 AC230/DC220	R16 574.87

Adjustable MCCB	Product Code	Item Description	Price
	NM8-125S/3P-100A-TM	50KA 100A 3P MCCB (Thermal/Magnetic 0.8-1In)	R3 425.20
	NM8-125S/3P-125A-TM	50KA 125A 3P MCCB (Thermal/Magnetic 0.8-1In)	R3 425.20
	NM8-250S/3P-160A-TM	50KA 160A 3P MCCB (Thermal/Magnetic 0.8-1In)	R4 996.84
	NM8-250S/3P-200A-TM	50KA 200A 3P MCCB (Thermal/Magnetic 0.8-1In)	R4 996.84
	NM8-250S/3P-250A-TM	50KA 250A 3P MCCB (Thermal/Magnetic 0.8-1In)	R4 996.84
	NM8-400S/3P-315A-TM	70KA 315A 3P MCCB (Thermal/Magnetic 0.8-1In)	R9 366.41
	NM8-400S/3P-400A-TM	70KA 400A 3P MCCB (Thermal/Magnetic 0.8-1In)	R9 366.41

	NM8-630S/3P-500A-TM	70KA 500A 3P MCCB (Thermal/Magnetic 0.8-1In)	R10 448.14
	NM8-800S/3P-630A-TM	50KA 630A 3P MCCB (Thermal/Magnetic 0.8-1In)	R30 682.85
	NM8-800S/3P-800A-TM	50KA 800A 3P MCCB (Thermal/Magnetic 0.8-1In)	R30 682.85
	NM8-800H/3P-800A-TM	70KA 800A 3P MCCB (Thermal/Magnetic 0.8-1In)	R32 821.41
	NM8-1250S/3P-1000A-TM	50KA 1000A 3P MCCB (Thermal/Magnetic 0.8-1In)	R30 879.42
	NM8-1250H/3P-1000A-TM	70KA 1000A 3P MCCB (Thermal/Magnetic 0.8-1In)	R40 171.11

	NM8-1250S/4P-1000-TM	50KA 1000A 4P MCCB (Thermal/Magnetic 0.8-1In)	R48 183.49



	NM8S-250S/3P-100A-E	70KA 100A 3P MCCB (Electronic 0.4-1In)	R7 320.94
	NM8S-250S/3P-125A-E	70KA 125A 3P MCCB (Electronic 0.4-1In)	R7 320.94
	NM8S-250S/3P-160A-E	70KA 160A 3P MCCB (Electronic 0.4-1In)	R7 320.95
	NM8S-250S/3P-250A-E	70KA 250A 3P MCCB (Electronic 0.4-1In)	R7 320.95
	NM8S-400S/3P-315A-E	70KA 315A 3P MCCB (Electronic 0.4-1In)	R14 679.37
	NM8S-400S/3P-400A-E	70KA 400A 3P MCCB (Electronic 0.4-1In)	R14 679.37
	NM8S-630S/3P-500A-E	70KA 500A 3P MCCB (Electronic 0.4-1In)	R16 180.24
	NM8S-630S/3P-630A-E	70KA 630A 3P MCCB (Electronic 0.4-1In)	R16 180.24

Adjustable MCCB	Product Code	Item Description	Price
	NM8S-800S/3P-800A-E	50KA 800A 3P MCCB (Electronic 0.4-1In)	R33 027.62
	NM8S-800H/3P-800A-E	80KA 800A 3P MCCB (Electronic 0.4-1In)	R34 578.26
	NM8S-1250S/3P-1250-E	50KA 1250A 3P MCCB (Electronic 0.4-1In) & Copper Connection Plates	R44 038.00
	NM8S-1600S/3P-1600-E	50KA 1600A 3P MCCB (Electronic 0.4-1In) & Copper Connection Plates	R55 185.39
	NM8S-1600H/3P-1600-E	70KA 1600A 3P MCCB (Electronic 0.4-1In) & Copper Connection Plates	R57 764.14

NM8(S) Accessories	Product Code	Item Description	Price
	AUX-NM8-LH	Auxiliary Switch NM8 L/Hand	R756.92
	ST-NM8-125-230V	Shunt Trip Release NM8-125 230V	R1 120.29
	ST-NM8-125-400V	Shunt Trip Release NM8-125 400V	R1 120.29
	ST-NM8(S)-250-230V	Shunt Trip Release NM8(S)250/400/630; NM8S-125 230V	R1 120.29
	ST-NM8(S)-250-380V	Shunt Trip Release NM8(S)250/400/630; NM8S-125 380V	R1 120.29
	ST-NM8(S)-800/1250-230V	Shunt Trip Release NM8(S)-800/1250-230V	R2 966.23
	ST-NM8(S)-800/1250-400V	Shunt Trip Release NM8(S)-800/1250-400V	R2 966.23

	OH-NM8-250-300mm	Operating Handle NM8S-125/250 NM8-250 3P 300mm	R1 177.86
	OH-NM8(S)-400/630-300mm	Operating Handle NM8(S)-400/630 300mm	R1 177.86
	OH-NM8(S)-800/1250-300mm	Operating Handle NM8(S)-800/1250 300mm	R2 236.56
	CU-NM8(S)-400/630	Copper Connection Plate for NM8-400/630 3P	R2 221.60
	CU-NM8(S)-800/1250	Copper Connection Plate for NM8-800/1250S 3P	R6 440.02
	EM-NM8(S)-400/630	Electro Motor NM8(S) 400/630-AC230/DC220	R17 608.14
	EM-NM8(S)-800/1250	Electro Motor NM8(S) 800/1250-AC230/DC220	R17 608.14

**NEW** NM8N: Full Range of Ics=100%Icu

Adjustable MCCB	Product Code	Item Description	Price
	NM8N-125S/3P-25A-TM	50KA 25A 3P MCCB (Thermal/Magnetic 0.7-1In)	R3 901.17
	NM8N-125S/3P-50A-TM	50KA 50A 3P MCCB (Thermal/Magnetic 0.7-1In)	R3 901.17
	NM8N-125S/3P-63A-TM	50KA 63A 3P MCCB (Thermal/Magnetic 0.7-1In)	R3 901.17
	NM8N-125S/3P-80A-TM	50KA 80A 3P MCCB (Thermal/Magnetic 0.7-1In)	R3 901.17
	NM8N-125S/3P-100A-TM	50KA 100A 3P MCCB (Thermal/Magnetic 0.7-1In)	R3 901.17
	NM8N-125S/3P-125A-TM	50KA 125A 3P MCCB (Thermal/Magnetic 0.7-1In)	R3 901.17
	NM8N-250S/3P-160A-TM	50KA 160A 3P MCCB (Thermal/Magnetic 0.7-1In)	R5 465.92
	NM8N-250S/3P-180A-TM	50KA 180A 3P MCCB (Thermal/Magnetic 0.7-1In)	R5 465.92
	NM8N-250S/3P-200A-TM	50KA 200A 3P MCCB (Thermal/Magnetic 0.7-1In)	R5 465.92
	NM8N-250S/3P-225A-TM	50KA 225A 3P MCCB (Thermal/Magnetic 0.7-1In)	R5 465.92
NM8N-250S/3P-250A-TM	50KA 250A 3P MCCB (Thermal/Magnetic 0.7-1In)	R5 465.92	
NM8N-250H/3P-160A-TM	100KA 160A 3P MCCB (Thermal/Magnetic 0.7-1In)	R5 517.00	
	NM8N-400S/3P-315A-TM	50KA 315A 3P MCCB (Thermal/Magnetic 0.7-1In)	R10 771.36
	NM8N-400S/3P-350A-TM	50KA 350A 3P MCCB (Thermal/Magnetic 0.7-1In)	R10 771.36
	NM8N-400S/3P-400A-TM	50KA 400A 3P MCCB (Thermal/Magnetic 0.7-1In)	R10 771.36
	NM8N-630S/3P-500A-TM	50KA 500A 3P MCCB (Thermal/Magnetic 0.7-1In)	R12 015.37
	NM8N-800H/3P-630A-TM	100KA 630A 3P MCCB (Thermal/Magnetic 0.7-1In)	R35 141.60
	NM8N-800H/3P-700A-TM	100KA 700A 3P MCCB (Thermal/Magnetic 0.7-1In)	R35 141.60
	NM8N-800H/3P-800A-TM	100KA 800A 3P MCCB (Thermal/Magnetic 0.7-1In)	R35 141.60
	NM8N1600S/3P-1000-TM	50KA 1000A 3P MCCB (Thermal/Magnetic 0.7-1In)	R45 260.67
	NM8N1600S/3P-1250-TM	50KA 1250A 3P MCCB (Thermal/Magnetic 0.7-1In)	R45 260.67
	NM8N1600S/3P-1600-TM	50KA 1600A 3P MCCB (Thermal/Magnetic 0.7-1In)	R45 260.67

Adjustable MCCB	Product Code	Item Description	Price
	NM8N1600S/4P-1000-TM	50KA 1000A 4P MCCB (Thermal/Magnetic 0.7-1In)	R60 649.29
	NM8N1600S/4P-1250-TM	50KA 1250A 4P MCCB (Thermal/Magnetic 0.7-1In)	R60 649.29
	NM8N1600S/4P-1600-TM	50KA 1600A 4P MCCB (Thermal/Magnetic 0.7-1In)	R60 649.29
	NM8N-250S/3P-100A-EN	50KA 100A 3P MCCB (Electronic 0.4-1In)	R7 687.00
	NM8N-250S/3P-160A-EN	50KA 160A 3P MCCB (Electronic 0.4-1In)	R7 687.00
	NM8N-250S/3P-250A-EN	50KA 250A 3P MCCB (Electronic 0.4-1In)	R7 687.00
	NM8N-400S/3P-250A-EN	50KA 250A 3P MCCB (Electronic 0.4-1In)	R15 409.96
	NM8N-400S/3P-400A-EN	50KA 400A 3P MCCB (Electronic 0.4-1In)	R15 409.96
	NM8N-630S/3P-630A-EN	50KA 630A 3P MCCB (Electronic 0.4-1In)	R16 989.24
	NM8N-800S/3P-800A-EN	50KA 800A 3P MCCB (Electronic 0.4-1In)	R36 330.39
	NM8N-1600H/3P-1000A-EN	100KA 1000A 3P MCCB (Electronic 0.4-1In)	R57 944.66
	NM8N-1600H/3P-1250A-EN	100KA 1250A 3P MCCB (Electronic 0.4-1In)	R57 944.66
	NM8N-1600Q/3P-1600A-EN	70KA 1600A 3P MCCB (Electronic 0.4-1In) & Electro Motor	R62 545.13
	NM8N-800Q/3P-630-EM	70KA 630A 3P MCCB (Electronic 0.4-1In) LCD display	R24 472.81
	NM8N-800Q/3P-800-EM	70KA 800A 3P MCCB (Electronic 0.4-1In) LCD display	R33 953.63
	NM8N1600Q/3P-1600-EM	70KA 1600A 3P MCCB (Electronic 0.4-1In) LCD display	R57 944.66
	NM8N1600H/3P-1600-EM	100KA 1600A 3P MCCB (Electronic 0.4-1In) & Electro Motor LCD Display	R87 494.62
	PSU22-M8	Battery box for NM8N LCD Display (No Battery)	R608.98
	NM8N-250HVS/3P-250A	30KA 250A 3P AC1000V MCCB (Thermal/M 0.7-1In)	R8 280.90
	NM8N-400HVS/3P-400A	35KA 400A 3P AC1000V MCCB (Thermal/M 0.7-1In)	R16 265.84
	NM8N-630HVS/3P-500A	35KA 500A 3P AC1000V MCCB (Thermal/M 0.7-1In)	R17 358.77

AC1000V

## NM8N Accessories



Product Code	Item Description	Price
OH-NM8N-125-300mm	Rotary Handle 300mm for NM8N-125	R1 165.87
OH-NM8N-250-300mm	Rotary Handle 300mm for NM8N-250	R1 165.87
OH-NM8N-400/630-300mm	Rotary Handle 300mm for NM8N-400/630	R1 460.45
OH-NM8N-800-300mm	Rotary Handle 300mm for NM8N-800	R1 947.32
OH-NM8N-1600-300mm	Rotary Handle 300mm for NM8N-1600	R3 613.00
CU-NM8N-800 3P	Copper Connection Plate for NM8N-800 3P	R4 561.11
CU-NM8N-1000/1250 3P	Copper Connection Plate for NM8N-1000/1250 3P	R4 919.03
CU-NM8N-1000/1250 4P	Copper Connection Plate for NM8N-1000/1250 4P	R6 417.31
CU-NM8N-1600 3P	Copper Connection Plate for NM8N-1600 3P	R6 440.03



ST-NM8N-125-240V	Shunt Trip NM8N-125 AC220-240V	R1 104.26
ST-NM8N-250/630-240V	Shunt Trip NM8N-250/630 AC220-240V	R1 104.26
ST-NM8N-800-240V	Shunt Trip NM8N-800 AC220-240V	R1 239.82
ST-NM8N-1600 240V	Shunt trip for NM8N-1600 AC220-240V	R1 487.04
UVR-NM8N-125 230V	Under Voltage Release NM8N-125 230V	R1 122.65
UVR-NM8N-125 400V	Under Voltage Release NM8N-125 400V	R1 122.65
UVR-NM8N-250-630 230V	Under Voltage Release NM8N-250-630 230V	R1 122.65
UVR-NM8N-250-630 400V	Under Voltage Release NM8N-250-630 400V	R1 122.65
UVR-NM8N -800 230V	Under Voltage Release NM8N-800 230V	R1 228.34
UVR-NM8N -800 400V	Under Voltage Release NM8N-800 400V	R1 228.34
UVR-NM8N -1600 230V	Under Voltage Release NM8N-1600 230V	R4 885.98
UVR-NM8N -1600 400V	Under Voltage Release NM8N-1600 400V	R4 885.98



EM-NM8N-250-230V	Electro Motor NM8N-400/630-AC230/DC220	R10 815.26
EM-NM8N-400/630	Electro Motor NM8N-400/630-AC230/DC220	R16 863.93
EM-NM8N-800-230V	Electro Motor NM8N-800 AC230/DC220	R16 863.93

## Air Circuit Breakers

ACB	Product Code	Item Description	Price
	NA1-2000X-630A-F	ACB 80kA 3P 630A Manual/Fixed ACB AC400	R66 963.56
	NA1-2000X-630A-D	ACB 80kA 3P 630A Manual/Drawout AC400	R81 797.25
	NA1-2000X-1000A-F	ACB 80kA 3P 1000A Manual/Fixed AC400	R70 050.19
	NA1-2000X-1000A-D	ACB 80kA 3P 1000A Manual/Drawout AC400	R87 050.37
	NA1-2000X-1600A-F	ACB 80kA 3P 1600A Manual/Fixed AC230	R74 810.28
	NA1-2000X-1600A-D	ACB 80kA 3P 1600A Manual/Drawout AC400	R88 567.97
	NA1-2000X-2000A-F	ACB 80kA 3P 2000A Manual/Fixed AC400	R75 837.67
	NA1-2000X-2000A-D	ACB 80kA 3P 2000A Manual/Drawout AC400	R94 924.87
	NA1-3200X-2500A-F	ACB 80kA 3P 2500A Manual/Fixed AC400	R105 667.49
	NA1-3200X-2500A-D	ACB 80kA 3P 2500A Manual/Drawout AC400	R148 122.99
	NA1-3200X-3200A-F	ACB 80kA 3P 3200A Manual/Fixed AC400	R106 913.85
	NA1-3200X-3200A-D	ACB 80kA 3P 3200A Manual/Drawout AC400	R165 064.07
	NA1-4000X-4000A-D	ACB 80kA 3P 4000A Manual/Drawout AC400	R209 746.67
	NA1-6300X-5000A(M)-D	ACB 80kA 3P 5000A Motor/Drawout AC400	R375 340.23

ACB Accessories	Product Code	Item Description	Price
	AUX-NA1-4NO/4NC	NA1-Auxiliary Contacts 4NO/4NC	R1 137.22
	MI-MCI-PLATE	Mechanical Cable Interlock Fixing Plate for NA1-2000-4000A	R107.16
	MI-NA1-COMPLETE	Mechanical Cable Interlock for NA1-2000-6300	R9 484.86
	ST-NA1-DC24V	Shunt Trip Release NA1 DC24V	R1 866.32
	ST-NA1-110V	Shunt Trip Release NA1 AC110V	R1 696.65
	ST-NA1-240V	Shunt Trip Release NA1 AC240V	R1 696.65
	ST-NA1-400V	Shunt Trip Release NA1 AC400V	R1 696.65
	CM-NA1-DC24V	Closing Magnet NA1-630-3200A DC24V	R1 942.11
	CM-NA1-220V	Closing Magnet NA1-2000-6300A AC220/230V	R1 942.11
	CM-NA1-400V	Closing Magnet NA1-2000-6300 AC400V	R1 942.11
	UVR-NA1-230V	Under Voltage Release, NA1-2000-4000A AC230V	R1 187.72
	UVR-NA1-400V	Under Voltage Release, NA1-2000-4000A AC400V	R1 187.72
	EM-NA1-20-DC24	Electro Motor for NA1-630-2000A DC24V	R8 368.13
	EM-NA1-20-110V	Electro Motor for NA1-630-2000A AC/DC110V	R8 368.12
	EM-NA1-20-230V	Electro Motor for NA1-630-2000A AC230/DC220V	R8 368.12
	EM-NA1-20-400V	Electro Motor for NA1-630-2000A AC400V	R8 368.12
	EM-NA1-40-DC24	Electro Motor NA1-2500-4000A DC24V	R8 368.12
	EM-NA1-40-110V	Electro Motor NA1-2500-4000A AC/DC110V	R8 368.12
	EM-NA1-40-230V	Electro Motor NA1-2500-4000A AC230V	R8 368.12
	EM-NA1-40-400V	Electro Motor NA1-2500-4000A AC400V	R8 368.12
	EM-NA1-63-230V	Electro Motor NA1-4000-6300A AC230/DC220V	R9 424.25
	EM-NA1-63-400V	Electro Motor NA1-4000-6300A AC400V	R9 424.25

**Note:** When ordering Mechanical Cable Interlock for fixed type ACB, each ACB needs a separate fixing plate to be ordered.



## Earth Leakage

RCCB	Product Code	Item Description	Price
	NL1-63-1P+N-25-30mA	6kA 1P+N 25A Earth Leakage 30mA	R635.29
	NL1-63-1P+N-40-30mA	6kA 1P+N 40A Earth Leakage 30mA	R632.96
	NL1-63-1P+N-63-30mA	6kA 1P+N 63A Earth Leakage 30mA	R441.11
	NL1-63-3P+N-25-30mA	6kA 3P+N 25A Earth Leakage 30mA	R908.52
	NL1-63-3P+N-40-30mA	6kA 3P+N 40A Earth Leakage 30mA	R941.00
	NL1-63-3P+N-63-30mA	6kA 3P+N 63A Earth Leakage 30mA	R1 030.05
	NL1-100-4P-080-30mA	6kA 3P+N 80A Earth Leakage 30mA	R1 170.10
	NL1-100-4P-100-30mA	6kA 3P+N 100A Earth Leakage 30mA	R1 211.19

RCBO	Product Code	Item Description	Price
	NB1L-40-1P+N-C20	6kA 1P+N 20A Earth Leakage 30mA OL Protection	R645.50
	NB1L-40-1P+N-C40	6kA 1P+N 40A Earth Leakage 30mA OL Protection	R645.50
	NB1L-63-1P+N-C63	6kA 1P+N 63A Earth Leakage 30mA OL Protection	R923.16
	NB1L-40-3P+N-C25	6kA 3P+N 25A Earth Leakage 30mA OL Protection	R1 167.69
	NB1L-40-3P+N-C40	6kA 3P+N 40A Earth Leakage 30mA OL Protection	R1 240.57
	NB1L-63-3P+N-C50	6kA 3P+N 50A Earth Leakage 30mA OL Protection	R1 425.27
	NB1L-63-3P+N-C63	6kA 3P+N 63A Earth Leakage 30mA OL Protection	R1 736.77
	DZ158LE-1P+N-80A	6kA 1P+N 80A Earth Leakage 100mA OL Protection	R673.90
DZ158LE-1P+N-100A	6kA 1P+N 100A Earth Leakage 100mA OL Protection	R686.99	

	NXMLE-125H/4 125A	36KA 3P+N 125A Earth Leakage OL Protection	R2 510.10
	NXMLE-160H/4 160A	36KA 3P+N 160A Earth Leakage OL Protection	R2 818.35
	NXMLE-250H/4 250A	50KA 3P+N 250A Earth Leakage OL Protection	R3 655.05
	NXMLE-400H/4 400A	50KA 3P+N 400A Earth Leakage OL Protection	R8 895.50
	NXMLE-630H/4 630A	50KA 3P+N 630A Earth Leakage OL Protection	R10 084.50

RCCB	Product Code	Item Description	Price
	NB2LE 1P+N-25	6KA 1P+N 25A Earth Leakage 30mA OL Protection	R538.84



## Surge Arrestors

Surge Arrestors	Product Code	Item Description	Price
	NU6-II-40KA/385V-1P	Surge Arrestor 40kA 385V 1P	R375.97
	NU6-II-60KA/385V-1P	Surge Arrestor 60kA 385V 1P	R552.39
	NU6-II-100KA/385V-1P	Surge Arrestor 100kA 385V 1P	R1 118.21
	NU6-II-100KA/385V-2P	Surge Arrestor 100kA 385V 2P	R2 114.90
	NU6-II-40KA/385V-4P	Surge Arrestor 40kA 385V 4P	R1 345.67
	NU6-II-60KA/385V-4P	Surge Arrestor 60kA 385V 4P	R2 219.03
	NU6-II-100KA/385V-4P	Surge Arrestor 100kA 385V 4P	R4 429.40

	NU6-IIG-1P-40KA-275V	Surge Arrestor 40kA 275V 1P	R375.96
	NU6-IIG-1P-40KA-385V	Surge Arrestor 40kA 385V 1P	R375.96
	NU6-IIG-2P-40KA/275V	Surge Arrestor 40kA 275V 2P	R720.69
	NU6-IIG-2P-40KA/385V	Surge Arrestor 40kA 385V 2P	R720.69
	NU6-IIG-4P-40KA/385V	Surge Arrestor 40kA 385V 4P	R1 507.16





An extensive range of quality products that are known for its reliability.

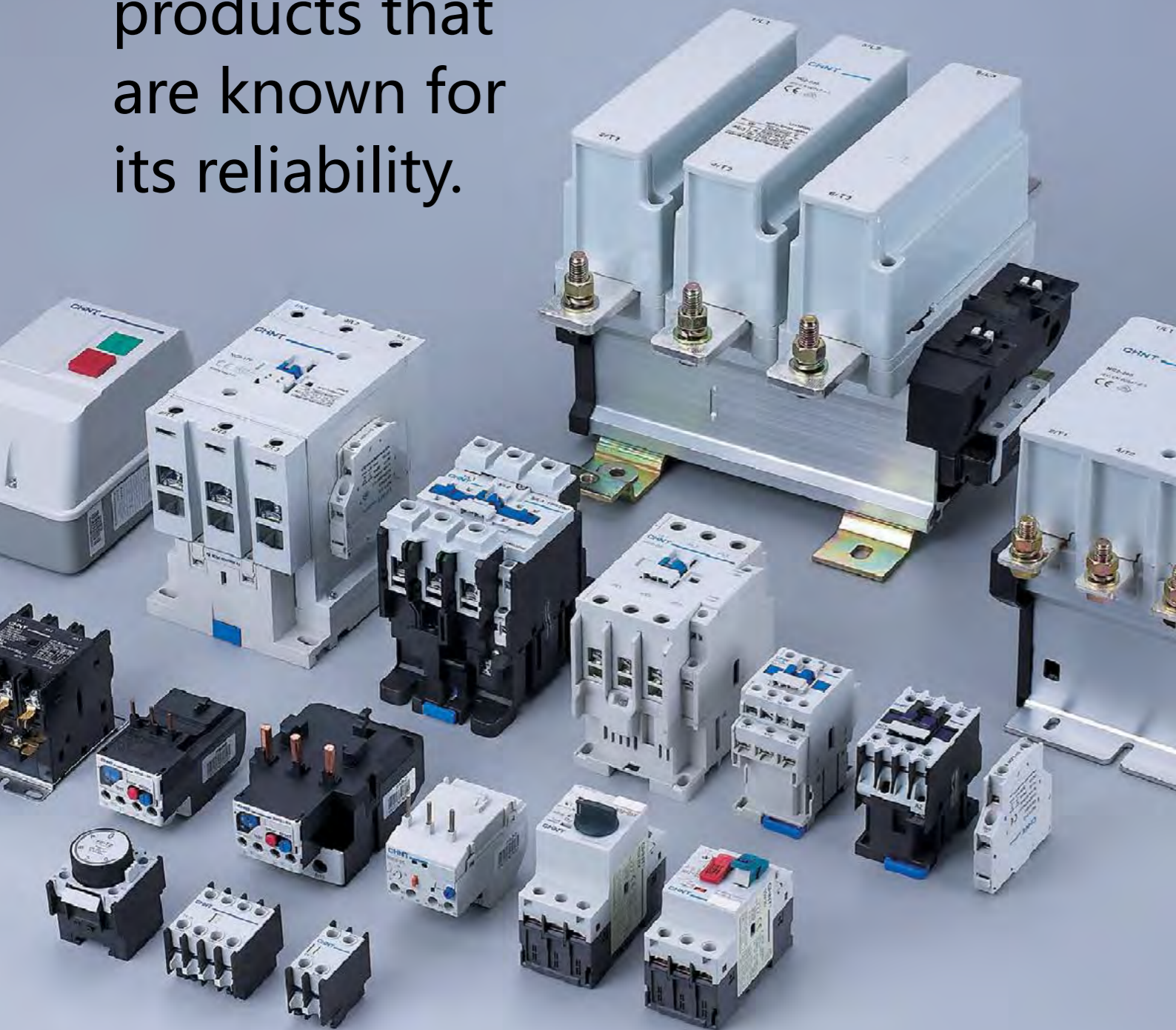

## Contactors

Product Code	Item Description	Price
NC6-0901-240V	Contactor 9A 3NO Main+1NC Aux 240V	R330.47
NC6-0908-240V	Contactor 9A 2NO+2NC Main 240V	R330.47
NC6-0910-24V	Contactor 9A 3NO Main+1NO Aux 24V	R330.47
NC6-0910-240V	Contactor 9A 3NO Main+1NO Aux 240V	R330.47
NC6-0910-415V	Contactor 9A 3NO Main+1NO Aux 415V	R330.47
NCH8-20A/11-230	Modular Contactor 20A 1NO+1NC 230V	R264.34
NCH8-20A/20-230	Modular Contactor 20A 2NO 230V	R264.34
NCH8-25A/40-230	Modular Contactor 25A 4NO 230V	R467.70
NCH8-40A/20-230	Modular Contactor 40A 2NO 230V	R559.81
NCH8-40A/40-230	Modular Contactor 40A 4NO 230V	R827.14
NCH8-63A/40-230	Modular Contactor 63A 4NO 230V	R827.14
NCH8-63A/22-230	Modular Contactor 63A 2NO+2NC 230V	R827.14
NCH8-20M/20-230	Modular Contactor 20A 2NO 230V with handle	R411.59
NCH8-25M/20-230	Modular Contactor 25A 2NO 230V with handle	R411.59
NCH8-40M/20-230	Modular Contactor 40A 2NO 230V with handle	R823.16
NCH8-40M/40-230	Modular Contactor 40A 4NO 230V with handle	R1 173.01
NCH8-63M/22-230	Modular Contactor 63A 2NO+2NC 230V with handle	R1 173.01
NCH8-63M/20-230	Modular Contactor 63A 2NO 230V with handle	R823.16
NCH8-63M/40-230	Modular Contactor 63A 4NO 230V with handle	R1 173.01
AUX-NCF6-22	Front Mount Auxiliary Contact for NC6 2NO+2NC	R244.19

Product Code	Item Description	Price
NC1-0901-024V	Contactora 9A 3NO Main+1NC Aux 24V 50/60Hz	R321.42
NC1-0901-240V	Contactora 9A 3NO Main+1NC Aux 240V 50/60Hz	R321.42
NC1-0901-415V	Contactora 9A 3NO Main+1NC Aux 415V 50/60Hz	R321.42
NC1-0904-240V	Contactora 9A 4NO Main 240V 50/60Hz	R327.13
NC1-0904-415V	Contactora 9A 4NO Main 415V 50/60Hz	R327.13
NC1-0908-240V	Contactora 9A 2NO+2NC Main 240V 50/60Hz	R327.13
NC1-0908-415V	Contactora 9A 2NO+2NC Main 415V 50/60Hz	R327.13
NC1-0910-024V	Contactora 9A 3NO Main+1NO Aux 24V 50/60Hz	R321.42
NC1-0910-048V	Contactora 9A 3NO Main+1NO Aux 48V 50/60Hz	R321.42
NC1-0910-110V	Contactora 9A 3NO Main+1NO Aux 110V 50/60Hz	R321.42
NC1-0910-240V	Contactora 9A 3NO Main+1NO Aux 240V 50/60Hz	R321.42
NC1-0910-415V	Contactora 9A 3NO Main+1NO Aux 415V 50/60Hz	R321.42



NC1-1201-024V	Contactora 12A 3NO Main + 1NC Aux 24V 50/60Hz	R333.81
NC1-1201-048V	Contactora 12A 3NO Main+1NC Aux 48V 50/60Hz	R333.81
NC1-1201-110V	Contactora 12A 3NO Main + 1NC Aux 110V 50/60Hz	R333.81
NC1-1201-240V	Contactora 12A 3NO Main+1NC Aux 240V 50/60Hz	R333.81
NC1-1201-415V	Contactora 12A 3NO Main+1NC Aux 415V 50/60Hz	R333.81
NC1-1204-024V	Contactora 12A 4NO Main 24V 50/60Hz	R327.13
NC1-1204-240V	Contactora 12A 4NO Main 240V 50/60Hz	R327.13
NC1-1204-415V	Contactora 12A 4NO Main 415V 50/60Hz	R327.13
NC1-1208-240V	Contactora 12A 2NO+2NC Main 240V 50/60Hz	R327.13
NC1-1208-415V	Contactora 12A 2NO+2NC Main 415V 50/60Hz	R327.13
NC1-1210-024V	Contactora 12A 3NO Main+1NO Aux 24V 50/60Hz	R333.81
NC1-1210-048V	Contactora 12A 3NO Main+1NO Aux 48V 50/60Hz	R333.81
NC1-1210-110V	Contactora 12A 3NO Main+1NO Aux 110V 50/60Hz	R333.81
NC1-1210-240V	Contactora 12A 3NO Main+1NO Aux 240V 50/60Hz	R333.81
NC1-1210-415V	Contactora 12A 3NO Main+1NO Aux 415V 50/60Hz	R333.81



Product Code	Item Description	Price
NC1-1801-024V	Contactora 18A 3NO Main+1NC Aux 24V 50/60Hz	R370.05
NC1-1801-048V	Contactora 18A 3NO Main+1NC Aux 48V 50/60Hz	R370.05
NC1-1801-110V	Contactora 18A 3NO Main+1NC Aux 110V 50/60Hz	R370.05
NC1-1801-240V	Contactora 18A 3NO Main+1NC Aux 240V 50/60Hz	R370.05
NC1-1801-415V	Contactora 18A 3NO Main+1NC Aux 415V 50/60Hz	R370.05
NC1-1810-024V	Contactora 18A 3NO Main+1NO Aux 24V 50/60Hz	R370.05
NC1-1810-048V	Contactora 18A 3NO Main+1NO Aux 48V 50/60Hz	R370.05
NC1-1810-110V	Contactora 18A 3NO Main+1NO Aux 110V 50/60Hz	R370.05
NC1-1810-240V	Contactora 18A 3NO Main+1NO Aux 240V 50/60Hz	R370.05
NC1-1810-415V	Contactora 18A 3NO Main+1NO Aux 415V 50/60Hz	R370.05



NC1-2501-024V	Contactora 25A 3NO Main+1NC Aux 24V 50/60Hz	R493.07
NC1-2501-110V	Contactora 25A 3NO Main+1NC Aux 110V 50/60Hz	R493.07
NC1-2501-240V	Contactora 25A 3NO Main+1NC Aux 240V 50/60Hz	R493.07
NC1-2501-415V	Contactora 25A 3NO Main+1NC Aux 415V 50/60Hz	R493.07
NC1-2510-024V	Contactora 25A 3NO Main+1NO Aux 24V 50/60Hz	R493.07
NC1-2510-048V	Contactora 25A 3NO Main+1NO Aux 48V 50/60Hz	R493.07
NC1-2510-110V	Contactora 25A 3NO Main+1NO Aux 110V 50/60Hz	R493.07
NC1-2510-240V	Contactora 25A 3NO Main+1NO Aux 240V 50/60Hz	R493.07
NC1-2510-415V	Contactora 25A 3NO Main+1NO Aux 415V 50/60Hz	R493.07
NC1-2504-240V	Contactora 25A 4NO Main 240V 50/60Hz	R543.62
NC1-2504-415V	Contactora 25A 4NO Main 415V 50/60Hz	R543.62
NC1-2508-048V	Contactora 25A 2NO+2NC Main 48V 50/60Hz	R543.62
NC1-2508-240V	Contactora 25A 2NO+2NC Main 240V 50/60Hz	R543.62
NC1-2508-415V	Contactora 25A 2NO+2NC Main 415V 50/60Hz	R543.62



Product Code	Item Description	Price
NC1-3201-024V	Contactora 32A 3NO Main+1NC Aux 24V 50/60Hz	R633.25
NC1-3201-110V	Contactora 32A 3NO Main+1NC Aux 110V 50/60Hz	R633.25
NC1-3201-240V	Contactora 32A 3NO Main+1NC Aux 240V 50/60Hz	R633.25
NC1-3201-415V	Contactora 32A 3NO Main+1NC Aux 415V 50/60Hz	R633.25
NC1-3210-024V	Contactora 32A 3NO Main+1NO Aux 24V AC 50/60Hz	R633.25
NC1-3210-048V	Contactora 32A 3NO Main+1NO Aux 48V AC 50/60Hz	R633.25
NC1-3210-110V	Contactora 32A 3NO Main+1NO Aux 110V 50/60Hz	R633.25
NC1-3210-240V	Contactora 32A 3NO Main+1NO Aux 240V 50/60Hz	R633.25
NC1-3210-415V	Contactora 32A 3NO Main+1NO Aux 415V 50/60Hz	R633.25



NC1-4011-024V	Contactora 40A 3NO Main+1NO+1NC Aux 24V 50/60Hz	R1 163.55
NC1-4011-048V	Contactora 40A 3NO Main+1NO+1NC Aux 48V 50/60Hz	R1 163.55
NC1-4011-110V	Contactora 40A 3NO Main+1NO+1NC Aux 110V 50/60Hz	R1 163.55
NC1-4011-240V	Contactora 40A 3NO Main+1NO+1NC Aux 240V 50/60Hz	R1 163.55
NC1-4011-415V	Contactora 40A 3NO Main+1NO+1NC Aux 415V 50/60Hz	R1 163.55
NC1-4004-110V	Contactora 40A 4NO Main 110V 50/60Hz	R1 532.25
NC1-4004-240V	Contactora 40A 4NO Main 240V 50/60Hz	R1 540.00



NC1-5011-024V	Contactora 50A 3NO Main+1NO+1NC Aux 24V 50/60Hz	R1 209.32
NC1-5011-048V	Contactora 50A 3NO Main+1NO+1NC Aux 48V 50/60Hz	R1 209.32
NC1-5011-110V	Contactora 50A 3NO Main+1NO+1NC Aux 110V 50/60Hz	R1 209.32
NC1-5011-240V	Contactora 50A 3NO Main+1NO+1NC Aux 240V 50/60Hz	R1 209.32
NC1-5011-415V	Contactora 50A 3NO Main+1NO+1NC Aux 415V 50/60Hz	R1 209.32
NC1-5004-240V	Contactora 50A 4NO Main 240V 50/60Hz	R1 576.53
NC1-5008-240V	Contactora 50A 2NO+2NC Main 240V 50/60Hz	R1 576.53



Product Code	Item Description	Price
NC1-6511-024V	Contactora 65A 3NO Main+1NO+1NC 24V 50/60Hz	R1 477.35
NC1-6511-048V	Contactora 65A 3NO Main+1NO+1NC 48V 50/60Hz	R1 477.35
NC1-6511-110V	Contactora 65A 3NO Main+1NO+1NC 110V 50/60Hz	R1 477.35
NC1-6511-240V	Contactora 65A 3NO Main+1NO+1NC 240V 50/60Hz	R1 477.35
NC1-6511-415V	Contactora 65A 3NO Main+1NO+1NC 415V 50/60Hz	R1 477.35
NC1-6504-110V	Contactora 65A 4NO Main 110V 50/60Hz	R2 095.32
NC1-6504-240V	Contactora 65A 4NO Main 240V 50/60Hz	R2 095.32
NC1-6504-415V	Contactora 65A 4NO Main 415V 50/60Hz	R2 095.32
NC1-6508-024V	Contactora 65A 2NO+2NC Main 24V 50/60Hz	R2 095.32
NC1-6508-110V	Contactora 65A 2NO+2NC Main 110V 50/60Hz	R2 095.32
NC1-6508-240V	Contactora 65A 2NO+2NC Main 240V 50/60Hz	R1 985.04
NC1-6508-415V	Contactora 65A 2NO+2NC Main 415V 50/60Hz	R1 985.04



NC1-8011-110V	Contactora 80A 3NO Main+1NO+1NC 110V 50/60Hz	R2 186.11
NC1-8011-240V	Contactora 80A 3NO Main+1NO+1NC 240V 50/60Hz	R2 186.11
NC1-8011-415V	Contactora 80A 3NO Main+1NO+1NC 415V 50/60Hz	R2 186.11
NC1-8004-110V	Contactora 80A 4NO Main 110V 50/60Hz	R2 859.21
NC1-8004-240V	Contactora 80A 4NO Main 240V 50/60Hz	R2 859.21
NC1-8008-240V	Contactora 80A 2NO+2NC Main 240V 50/60Hz	R2 859.21
NC1-8008-415V	Contactora 80A 2NO+2NC Main 415V 50/60Hz	R2 859.21



NC1-9511-024V	Contactora 95A 3NO Main+1NO+1NC 24V 50/60Hz	R2 297.94
NC1-9511-110V	Contactora 95A 3NO Main+1NO+1NC 110V 50/60Hz	R2 297.94
NC1-9511-240V	Contactora 95A 3NO Main+1NO+1NC 240V 50/60Hz	R2 297.94
NC1-9511-415V	Contactora 95A 3NO Main+1NO+1NC 415V 50/60Hz	R2 297.94
NC1-9504-240V	Contactora 95A 4NO Main 240V 50/60Hz	R2 859.21
NC1-9508-240V	Contactora 95A 2NO+2NC 240V 50/60Hz	R2 859.21



Product Code	Item Description	Price
NC1-0901Z-DC24	Contacteur 09A 3NO Main+1NC Aux 24V DC	R708.98
NC1-0901Z-DC48	Contacteur 09A 3NO Main+1NC Aux 48V DC	R708.98
NC1-1201Z-DC24	Contacteur 12A 3NO Main+1NC Aux 24V DC	R714.06
NC1-1201Z-DC48	Contacteur 12A 3NO Main+1NC Aux 48V DC	R714.06
NC1-1210Z-DC24	Contacteur 12A 3NO Main+1NO Aux 24V DC	R714.06
NC1-1210Z-DC48	Contacteur 12A 3NO Main+1NO Aux 48V DC	R714.06
NC1-1810Z-DC24	Contacteur 18A 3NO Main+1NO Aux 24V DC	R735.03
NC1-1810Z-DC110	Contacteur 18A 3NO Main+1NO Aux 110V DC	R820.22
NC1-2510Z-DC24	Contacteur 25A 3NO Main+1NO Aux 24V DC	R1 121.57
NC1-3210Z-DC24	Contacteur 32A 3NO Main+1NO Aux 24V DC	R1 298.86
NC1-3210Z-DC48	Contacteur 32A 3NO Main+1NC Aux 48V DC	R1 298.86



Product Code	Item Description	Price
NC2-115-110V	Contacteur 115A 3P 110V	R5 249.60
NC2-115-240V	Contacteur 115A 3P 240V	R5 249.60
NC2-115-400V	Contacteur 115A 3P 400V	R5 249.60
NC2-150-110V	Contacteur 150A 3P 110V	R5 498.57
NC2-150-240V	Contacteur 150A 3P 240V	R5 498.57
NC2-150-400V	Contacteur 150A 3P 400V	R5 498.57
NC2-150/4P-240V	Contacteur 150A 4P 240V	R7 580.50



Product Code	Item Description	Price
NC2-185-240V	Contacteur 185A 3P 240V	R6 862.19
NC2-185-400V	Contacteur 185A 3P 400V	R6 862.19
NC2-225-240V	Contacteur 225A 3P 240V	R8 457.10
NC2-225-400V	Contacteur 225A 3P 400V	R8 457.10
NC2-225/4P-240V	Contacteur 225A 4P 240V	R9 220.82
NC2-265-110V	Contacteur 265A 3P 110V	R9 406.79
NC2-265-240V	Contacteur 265A 3P 240V	R9 406.79
NC2-265-400V	Contacteur 265A 3P 400V	R9 406.79
NC2-265/4P-240V	Contacteur 265A 4P 240V	R13 097.90



Product Code	Item Description	Price
NC2-330-240V	Contacteur 330A 3P 240V	R13 760.97
NC2-330-400V	Contacteur 330A 3P 400V	R13 760.97
NC2-330/4P-240V	Contacteur 330A 4P 240V	R18 291.07
NC2-400-240V	Contacteur 400A 3P 240V	R13 925.77
NC2-400-400V	Contacteur 400A 3P 400V	R13 925.77
NC2-400/4P-240V	Contacteur 400A 4P 240V	R19 835.06



Product Code	Item Description	Price
NC2-500-240V	Contacteur 500A 3P 240V	R19 835.06
NC2-500-400V	Contacteur 500A 3P 400V	R19 835.06
NC2-630-240V	Contacteur 630A 3P 240V	R27 355.72
NC2-630-400V	Contacteur 630A 3P 400V	R27 355.72
NC2-630/4P-240V	Contacteur 630A 4P 240V	R38 843.44
NC2-800-240V	Contacteur 800A 3P 240V	R32 736.09
NC2-800-400V	Contacteur 800A 3P 400V	R32 736.09



Product Code	Item Description	Price
NC9-250-110V	Vacuum Contacteur 250A 110V	R19 722.24
CJX1-225/22-110V	Vacuum Contacteur 225A 110V AC/DC	R23 285.31
CJX1-225/22-220V	Vacuum Contacteur 225A 220V AC/DC	R23 285.31
CJX1-225/22-380V	Vacuum Contacteur 225A 380V AC/DC	R23 285.31
CJX1-265/22-110V	Vacuum Contacteur 265A 110V AC/DC	R23 285.31
CJX1-265/22-220V	Vacuum Contacteur 265A 220V AC/DC	R23 285.31
CJX1-265/22-380V	Vacuum Contacteur 265A 380V AC/DC	R23 285.31
CJX1-300/22-110V	Vacuum Contacteur 300A 110V AC/DC	R25 744.62
CJX1-300/22-220V	Vacuum Contacteur 300A 220V AC/DC	R25 744.62
CJX1-300/22-380V	Vacuum Contacteur 300A 380V AC/DC	R25 744.62



CJX1-400/22-110V	Vacuum Contacteur 400A 110V AC/DC	R34 505.48
CJX1-400/22-220V	Vacuum Contacteur 400A 220V AC/DC	R34 505.48
CJX1-400/22-380V	Vacuum Contacteur 400A 380V AC/DC	R34 505.48
CJX1-500/22-110V	Vacuum Contacteur 500A 110V AC/DC	R36 964.58
CJX1-500/22-220V	Vacuum Contacteur 500A 220V AC/DC	R36 964.58
CJX1-500/22-380V	Vacuum Contacteur 500A 380V AC/DC	R36 964.58
CJX1-630/44-110V	Vacuum Contacteur 630A 110V AC/DC	R64 668.87
CJX1-630/44-220V	Vacuum Contacteur 630A 220V AC/DC	R64 668.87
CJX1-630/44-380V	Vacuum Contacteur 630A 380V AC/DC	R64 668.87
CJX1-820/44-110V	Vacuum Contacteur 820A 110V AC/DC	R73 007.05
CJX1-820/44-220V	Vacuum Contacteur 820A 220V AC/DC	R73 007.05
CJX1-820/44-380V	Vacuum Contacteur 820A 380V AC/DC	R73 007.05



Product Code	Item Description	Price
AUX-F4-11	Top Mount Auxiliary Contact 1NO+1NC	R54.64
AUX-F4-02	Top Mount Auxiliary Contact 2NC	R54.64
AUX-F4-20	Top Mount Auxiliary Contact 2NO	R54.64
AUX-F4-22	Top Mount Auxiliary Contact 2NO+2NC	R84.81
AUX-F4-13	Top Mount Auxiliary Contact 1NO+3NC	R84.81
AUX-F4-31	Top Mount Auxillary Contact 3NO+1NC	R84.81
AUX-F4-04	Top Mount Auxiliary Contact 4NC	R84.81
AUX-F4-40	Top Mount Auxiliary Contact 4NO	R84.81
TIM-F5-D02	T/Mount Breaking Time Delay 0.1-30s	R611.90
TIM-F5-T02	T/Mount Making Time Delay 0.1-30s	R611.90
TIM-F5-T04	T/Mount Making Time Delay 10-180s	R611.90
AUX-NCF-11C	Side Mount Auxiliary Contact	R117.16
MI-NC1-09/32	Mechanical Interlock for NC1-09/32	R48.63
MI-NC1-40/65	Mechanical Interlock for NC1-40/65	R82.17
MI-NC1-80/95	Mechanical Interlock for NC1-80/95	R90.08
MI-NC1-8004/9504	Mechanical Interlock NC1-8004/9504	R114.91
MI-NC2-115/150	Horizontal Mechanical Interlock for NC2-115/150	R64.50
MI-NC2-185/225	Horizontal Mechanical Interlock for NC2-185/225	R70.65
MI-NC2-265/500	Horizontal Mechanical Interlock for NC2-265/500	R144.81
MI-NC2-630/800	Mechanical Interlock for NC2-630/800	R145.19



Product Code	Item Description	Price
CO-NC1-09/18-012	Coil For NC1-09/18 12VAC	R132.82
CO-NC1-09/18-024	Coil For NC1-09/18 24VAC	R132.82
CO-NC1-09/18-036	Coil For NC1-09/18 36VAC	R132.82
CO-NC1-09/18-048	Coil For NC1-09/18 48VAC	R132.82
CO-NC1-09/18-110	Coil For NC1-09/18 110VAC	R132.82
CO-NC1-09/18-240	Coil For NC1-09/18 240VAC	R132.82
CO-NC1-09/18-415	Coil For NC1-09/18 415VAC	R132.82
CO-NC1-09/18-525	Coil For NC1-09/18 525VAC	R132.82
CO-NC1-25/32-024	Coil For NC1-25/32 24VAC	R175.30
CO-NC1-25/32-036	Coil For NC1-25/32 36VAC	R175.30
CO-NC1-25/32-048	Coil For NC1-25/32 48VAC	R175.30
CO-NC1-25/32-110	Coil For NC1-25/32 110VAC	R175.30
CO-NC1-25/32-240	Coil For NC1-25/32 240VAC	R175.30
CO-NC1-25/32-415	Coil For NC1-25/32 415VAC	R175.30
CO-NC1-25/32-525	Coil For NC1-25/32 525VAC	R175.30
CO-NC1-40/95-024	Coil For NC1-40/95 24VAC	R307.19
CO-NC1-40/95-036	Coil For NC1-40/95 36VAC	R307.19
CO-NC1-40/95-048	Coil For NC1-40/95 48VAC	R307.19
CO-NC1-40/95-110	Coil For NC1-40/95 110VAC	R307.19
CO-NC1-40/95-240	Coil For NC1-40/95 240VAC	R307.19
CO-NC1-40/95-415	Coil For NC1-40/95 415VAC	R307.19
CO-NC1-40/95-525	Coil For NC1-40/95 525VAC	R307.19



**Technical data:**

Items	Model	NC1-09	NC1-12	NC1-18	NC1-25	NC1-32	NC1-40	NC1-50	NC1-65	NC1-80	NC1-95	NC2-115	NC2-150	
Rated operational Current (A)	400(380)V	AC-3	9A	12A	18A	25A	32A	40A	50A	65A	80A	95A	115A	150A
Power of controlled motor (AC-3)	kW	230(220)V AC	2.2	3	4	5.5	N/A	N/A	N/A	N/A	N/A	N/A	N/A	N/A
		400(380)V AC	4	5.5	7.5	11	15	18.5	22	30	37	45	55	75

Relevant contactor calculated at 415V		NC1-09 and NC1-12							NC1-12	NC1 18	NC1-25		NC1-32	NC1-40	NC1-50	NC1-65	NC1-80	NC1-95	NC2-115	NC2-150
Running current for motor ratings indicated at specific voltage	kW	0.37	0.55	0.75	1.1	1.5	2.2	4	5.5	7.5	10	11	15	18.5	22	30	37	45	55	75
	230V in A	1.3	1.9	2.6	3.8	5.2	7.6	13.9	19.1	N/A	N/A	N/A	N/A	N/A	N/A	N/A	N/A	N/A	N/A	N/A
	415V in A	0.9	1.4	1.8	2.4	3.3	4.7	8	11	14.3	19	20.5	28	34	40	54	66	78	95	128

Product Code	Item Description	Price
CO-NC2-115/150-110V	Coil For NC2-115/150 110VAC	R1 025.66
CO-NC2-115/150-240V	Coil For NC2-115/150 240VAC	R1 025.66
CO-NC2-115/150-400V	Coil For NC2-115/150 400VAC	R1 025.66
CO-NC2-185/225-110V	Coil For NC2-185/225 110VAC	R1 025.66
CO-NC2-185/225-240V	Coil For NC2-185/225 240VAC	R1 025.66
CO-NC2-185/225-400V	Coil For NC2-185/225 400VAC	R1 025.66
CO-NC2-265/330-110V	Coil For NC2-265/330 110VAC	R1 279.96
CO-NC2-265/330-240V	Coil For NC2-265/330 240VAC	R1 279.96
CO-NC2-265/330-400V	Coil For NC2-265/330 400VAC	R1 279.96
CO-NC2-400-110V	Coil For NC2-400 110VAC	R1 986.27
CO-NC2-400-230V	Coil For NC2-400 230VAC	R1 986.27
CO-NC2-400-400V	Coil For NC2-400 400VAC	R1 986.27
CO-NC2-500-110V	Coil For NC2-500 110VAC	R2 047.83
CO-NC2-500-240V	Coil for NC2-500 240VAC	R2 047.83
CO-NC2-500-400V	Coil for NC2-500 400VAC	R2 047.83
CO-NC2-630-110V	Coil for NC2-630 110VAC	R2 077.53
CO-NC2-630-240V	Coil For NC2-630 240VAC	R2 077.53
CO-NC2-630-400V	Coil for NC2-630 400VAC	R2 077.53
CO-NC2-630/4P-240V	Coil For NC2-630A/4P & 800A 3P 240VAC	R2 082.99
CO-NC2-630/4P-400V	Coil For NC2-630A/4P & 800A 3P 400VAC	R2 082.99
CO-NC2-115Z/150Z-110DC	Coil For NC2-115Z/150Z 110VDC	R890.26
CO-NC2-115Z/150Z-220DC	Coil For NC2-115Z/150Z 220VDC	R993.52
CO-NC2-185Z/225Z-110DC	Coil For NC2-185Z/225Z 110VDC	R997.75
CO-NC2-185Z/225Z-220DC	Coil For NC2-185Z/225Z 220VDC	R1 018.11
CO-NC2-265Z/330Z-110DC	Coil For NC2 -265Z/330Z 110VDC	R1 251.92
CO-NC2-265Z/330Z-220DC	Coil For NC2 -265Z/330Z 220VDC	R1 464.07



## Thermal Overload Relays

TOR	Product Code	Item Description	Price
	NR2-11.5/2.5-4A	Thermal Overload Relay 2.5-4A for NC6	R446.89
	NR2-25/0.25-0.4A	Thermal Overload Relay 0.25-0.4A	R297.06
	NR2-25/0.4-0.63A	Thermal Overload Relay 0.4-0.63A	R297.06
	NR2-25/0.63-1A	Thermal Overload Relay 0.63-1A	R297.06
	NR2-25/1-1.6A	Thermal Overload Relay 1.0-1.6A	R297.06
	NR2-25/1.6-2.5A	Thermal Overload Relay 1.6-2.5A	R297.06
	NR2-25/2.5-4A	Thermal Overload Relay 2.5-4A	R297.06
	NR2-25/4-6A	Thermal Overload Relay 4-6A	R297.06
	NR2-25/5.5-8A	Thermal Overload Relay 5.5-8.0A	R297.06
	NR2-25/7-10A	Thermal Overload Relay 7-10A	R297.06
	NR2-25/9-13A	Thermal Overload Relay 9-13A	R297.06
	NR2-25/12-18A	Thermal Overload Relay 12-18A	R297.06
	NR2-25/17-25A	Thermal Overload Relay 17-25A	R297.06
	NR2-25/23-32A	Thermal Overload Relay 23-32A	R392.10
	NR2-36/23-32A	Thermal Overload Relay 23-32A	R419.91
	NR2-36/28-36A	Thermal Overload Relay 28-36A	R419.91



COMING SOON!

## NXC Series AC Contactors

Next series | The Next Reliable Choice



TOR

Product Code	Item Description	Price
NR2-93/23-32A	Thermal Overload Relay 23-32A	R634.13
NR2-93/30-40A	Thermal Overload Relay 30-40A	R634.13
NR2-93/37-50A	Thermal Overload Relay 37-50A	R634.13
NR2-93/48-65A	Thermal Overload Relay 48-65A	R634.13
NR2-93/55-70A	Thermal Overload Relay 55-70A	R634.13
NR2-93/63-80A	Thermal Overload Relay 63-80A	R703.30
NR2-93/80-93A	Thermal Overload Relay 80-93A	R703.30
NR2-150/80-104A	Thermal Overload Relay 80-104A	R1 176.36
NR2-150/95-120A	Thermal Overload Relay 95-120A	R1 176.36
NR2-150/110-150A	Thermal Overload Relay 110-150A	R1 176.36
NR2-200/100-160A	Thermal Overload Relay 100-160A	R3 855.92
NR2-200/125-200A	Thermal Overload Relay 125-200A	R3 855.92
NR2-630/200-315A	Thermal Overload Relay 200-315A	R6 425.65



TOR Accessories

Product Code	Item Description	Price
MB-NR2-25	MB-2 base Mounting Block for NR2-25	R84.86
MB-NR2-36	MB-3 base Mounting Block for NR2-36	R157.63
MB-NR2-93	MB-4 base Mounting Block for NR2-93	R294.27



**COMING SOON!**

# NXR Series Thermal Overload Relays

**Next series** | The Next Reliable Choice



# Starters

MMS Starters

Product Code	Item Description	Price
NS2-25 0.25-0.4A	Manual Motor Starter 0.25-0.4A	R734.75
NS2-25 0.4-0.63A	Manual Motor Starter 0.4-0.63A	R734.75
NS2-25 0.63-1A	Manual Motor Starter 0.63-1.0A	R734.75
NS2-25 1-1.6A	Manual Motor Starter 1.0-1.6A	R734.75
NS2-25 1.6-2.5A	Manual Motor Starter 1.6-2.5A	R734.75
NS2-25 2.5-4A	Manual Motor Starter 2.5-4A	R734.75
NS2-25 4-6.3A	Manual Motor Starter 4-6.3A	R734.75
NS2-25 6-10A	Manual Motor Starter 6-10A	R734.75
NS2-25 9-14A	Manual Motor Starter 9-14A	R734.75
NS2-25 13-18A	Manual Motor Starter 13-1A	R734.75
NS2-25 17-23A	Manual Motor Starter 17-23A	R734.75
NS2-25 20-25A	Manual Motor Starter 20-25A	R734.75
NS2-32 24-32A	Manual Motor Starter 24-32A	R911.81
NS2-80B 25-40A	Manual Motor Starter 25-40A	R1 878.75
NS2-80B 40-63A	Manual Motor Starter 40-63A	R1 878.75
NS2-80B 56-80A	Manual Motor Starter 56-80A	R1 879.48



AUX-NS2-AE11	Front Mount Auxiliary Contact 1NO+1NC	R63.26
AUX-NS2-AU20	Side Mount Auxiliary Contact 2NO	R197.01
AUX-NS2-25-AU11	Side Mount Auxiliary Contact for NS2-25	R153.70
AUX-NS2-80B-AU11	Side Mount Auxiliary Contact for NS2-80B	R153.70
UVR-NS2 400V	Under Voltage Release NS2-400V	R391.54
UVR-NS2 220V	Under Voltage Release NS2-220V	R321.61
NS2-MC	Surface Enclosure for Manual Motor Starter	R282.71

DOL Starters	Product Code	Item Description	Price
	NQ2-15P/1 0.63-1A 400V	DOL Starter Steel 0.63-1A 400V	R1 301.84
	NQ2-15P/1 1-1.6A 400V	DOL Starter Steel 1.0-1.6A 400V	R1 301.84
	NQ2-15P/1 1.6-2.5 400V	DOL Starter Steel 1.6-2.5A 400V	R1 301.84
	NQ2-15P/1 2.5-4A 400V	DOL Starter Steel 2.5-4A 400V	R1 301.84
	NQ2-15P/1 2.5-4A 230V	DOL Starter Steel 2.5-4A 230V	R1 301.84
	NQ2-15P/1 5.5-8A 400V	DOL Starter Steel 5.5-8A 400V	R1 301.84
	NQ2-15P/1 7-10A 400V	DOL Starter Steel 7-10A 400V	R1 301.84
	NQ2-15P/1 9-13A 400V	DOL Starter Steel 9-13A 400V	R1 301.84
	NQ2-15P/2 12-18A 400V	DOL Starter Steel 12-18A 400V	R1 445.21
	NQ2-15P/2 17-25A 400V	DOL Starter Steel 17-25A 400V	R1 445.21

	NQ2-15P/1-230V	DOL Starter Steel NC1-1210 230V / No OL	R750.72
	NQ2-15P/1-400V	DOL Starter Steel NC1-1210 400V / No OL	R750.72
	NQ2-15P/2-230V	DOL Starter Steel NC1-1810 230V / No OL	R803.27
	NQ2-15P/2-400V	DOL Starter Steel NC1-1810 400V / No OL	R803.27
	NQ2-15P/3-230V	DOL Starter Steel NC1-2510 230V / No OL	R955.06
	NQ2-15P/3-400V	DOL Starter Steel NC1-2510 400V / No OL	R955.06
	NQ2-15P/4-230V	DOL Starter Steel NC1-3210 230V / No OL	R1 126.54
	NQ2-15P/4-400V	DOL Starter Steel NC1-3210 400V / No OL	R1 126.54

DOL Starters	Product Code	Item Description	Price
	NQ3-5.5P 1-1.6A 240V	DOL Starter 1-1.6A 240V IP55	R1 384.07
	NQ3-5.5P 1-1.6A 400V	DOL Starter 1-1.6A 400V IP55	R1 384.07
	NQ3-5.5P 1.6-2.5A 240V	DOL Starter 1.6-2.5A 240V IP55	R1 384.07
	NQ3-5.5P 1.6-2.5A 400V	DOL Starter 1.6-2.5A 400V IP55	R1 384.07
	NQ3-5.5P 2.5-4A 240V	DOL Starter 2.5-4A 240V IP55	R1 384.07
	NQ3-5.5P 2.5-4A 400V	DOL Starter 2.5-4A 400V IP55	R1 384.07
	NQ3-5.5P 4-6A 240V	DOL Starter 4-6A 240V IP55	R1 384.07
	NQ3-5.5P 4-6A 400V	DOL Starter 4-6A 400V IP55	R1 384.07
	NQ3-5.5P 5.5-8A 240V	DOL Starter 5.5-8A 240V IP55	R1 384.07
	NQ3-5.5P 5.5-8A 400V	DOL Starter 5.5-8A 400V IP55	R1 384.07
	NQ3-5.5P 7-10A 240V	DOL Starter 7-10A 240V IP55	R1 384.07
	NQ3-5.5P 7-10A 400V	DOL Starter 7-10A 400V IP55	R1 384.07
	NQ3-5.5P 9-13A 240V	DOL Starter 9-13A 240V IP55	R1 384.07
	NQ3-5.5P 9-13A 400V	DOL Starter 9-13A 400V IP55	R1 384.07

	NQ3-5.5P 240V	DOL Starter NC1-1810 240V / No OL IP55	R1 039.51
	NQ3-5.5P 400V	DOL Starter NC1-1810 400V / No OL IP55	R1 039.51
	NQ3-11P 240V	DOL Starter NC1-3210 240V / No OL IP55	R1 549.01
	NQ3-11P 400V	DOL Starter NC1-3210 400V / No OL IP55	R1 549.01



Full range of components to choose from.



## Push Buttons, Pilot Lights and Indicators

### Indicators



Product Code	Item Description	Price
ND9-1/G-230V	Single Indicator Light Green 230V	R116.29
ND9-1/R-230V	Single Indicator Light Red 230V	R116.29
ND9-2/GR-230V	Dual Indicator Light Green & Red 230V	R188.90

### Buzzers



Product Code	Item Description	Price
ND16-22FS-24V R	Buzzer Red AC/DC 24V	R134.88
ND16-22FS-AC240R	Buzzer Red AC240V	R149.61

Indicators	Product Code	Item Description	Price
	ND16-22BS-2-24B	LED Pilot Light 24V AC/DC Blue (Flat Round)	R46.75
	ND16-22BS-2-24R	LED Pilot Light 24V AC/DC Red (Flat Round)	R46.75
	ND16-22BS-2-24Y	LED Pilot Light 24V AC/DC Yellow (Flat Round)	R46.75
	ND16-22BS-2-24G	LED Pilot Light 24V AC/DC Green (Flat Round)	R46.75
	ND16-22BS-2-240O	LED Pilot Light 240V AC/DC Orange (Flat Round)	R49.20
	ND16-22BS-2-240Y	LED Pilot Light 240V AC/DC Yellow (Flat Round)	R49.20
	ND16-22BS-4-110O	LED Pilot Light 110VAC Orange (Flat Round)	R49.20
	ND16-22B-2-240W	LED Pilot Light 240V AC/DC White (Flat Round)	R55.56
	ND16-22BS-4-110W	LED Pilot Light 110VAC White (Flat Round)	R55.56
	ND16-22BS-4-110B	LED Pilot Light 110VAC Blue (Flat Round)	R49.20
	ND16-22BS-4-110Y	LED Pilot Light 110VAC Yellow (Flat Round)	R48.22
	ND16-22BS-4-110G	LED Pilot Light 110VAC Green (Flat Round)	R49.20
	ND16-22BS/4-110R	LED Pilot Light 110VAC Red (Flat Round)	R48.22
	ND16-22BS/4-240B	LED Pilot Light 240VAC Blue (Flat Round)	R48.22
	ND16-22BS-4-240R	LED Pilot Light 240VAC Red (Flat Round)	R48.22
	ND16-22BS-4-240G	LED Pilot Light 240VAC Green (Flat Round)	R48.22
	ND16-22BS/4-240Y	LED Pilot Light 240VAC Yellow (Flat Round)	R49.20
	ND16-22BS-4-240W	LED Pilot Light 240VAC White (Flat Round)	R55.56
ND16-22BS-4-400R	LED Pilot Light 400VAC Red (Flat Round)	R48.22	
	ND16-22CS-2-24B	LED Pilot Light 24V Blue (Arc surface)	R42.18
	ND16-22CS-2-24R	LED Pilot Light 24V Red (Arc surface)	R42.18
	ND16-22CS-2-24Y	LED Pilot Light 24V Yellow (Arc surface)	R42.18
	ND16-22CS-2-24G	LED Pilot Light 24V Green (Arc surface)	R42.18
	ND16-22CS-4-240R	LED Pilot Light 240V Red (Arc surface)	R47.23
	ND16-22CS-4-240G	LED Pilot Light 240V Green (Arc surface)	R47.23
	ND16-22CS-4-240Y	LED Pilot Light 240V Yellow (Arc surface)	R47.23
ND16-22CS-4-240B	LED Pilot Light 240V Blue (Arc surface)	R47.23	
			

Push Buttons (IP40)	Product Code	Item Description	Price
	NP2-BZ31	Legend Plate and Holder	R7.08
	NP2-BZ009	Metal Bezel For Pushbutton	R19.03
	NP2-BE101	Contact Block NO	R24.09
	NP2-BE102	Contact Block NC	R24.09
	NP2-BZ101	Contact Block 1NO With Mounting Block	R43.21
	NP2-BZ102	Contact Block 1NC With Mounting Block	R43.21
	NP2-BZ103	Contact Block 2NO With Mounting Block	R72.29
	NP2-BZ104	Contact Block 2NC With Mounting Block	R72.29
	NP2-BA03	Metal Flush Pushbutton Head Green 22mm	R28.06
	NP2-BA04	Metal Flush Pushbutton Head Red 22mm	R28.06
	NP2-BA11	Metal Pushbutton Head White+1NO Contact	R67.28
	NP2-BA21	Metal Pushbutton Head Black+1NO Contact	R67.28
	NP2-BA31	Metal Pushbutton Head Green+1NO Contact	R67.28
	NP2-BA41	Metal Pushbutton Head Red+1NO Contact	R63.25
	NP2-BA42	Metal Pushbutton Head Red+1NC Contact	R69.31
	NP2-BA51	Metal Pushbutton Head Yellow+1NO Contact	R69.31
	NP2-BA61	Metal Pushbutton Head Blue+1NO Contact	R69.31
		NP2-BD02	Selector Switch Head 2 position
NP2-BD03		Selector Switch Head 3 position	R34.11
NP2-BD23		Selector Switch 2P Complete 2NO	R88.32
NP2-BD33		3 Way Selector Switch Complete 2NO	R96.39
NP2-ED23		2 Way Selector Switch Stay Put 2NO PVC	R68.27
NP2-ED33		3 Way Selector Switch Stay Put 2NO PVC	R74.27
NP2-ED53		3 Way Selector Way Spring Return 2NO PVC	R74.27
NP2-EG25		2 Way Key Switch 1NO+1NC	R105.43
NP2-BG02		Key Selector Head 2 Position Stay put	R85.43
NP2-BG04		Key Selector Head 2 Position Spring Return	R77.32
	NP2-ES544	Emergency Stop Twist Release	R86.36
	NP2-BS541	Emergency Stop Twist Release 1NO	R88.32
	NP2-BS542	Emergency Stop Twist Release 1NC	R88.32
	NP2-BS54	Metal Emergency Stop Twist to Release	R50.19
	NP2-BL8325	Double Complete Button Flush	R110.44
	NP2-BL8425	Metal Double Head Square Raised	R110.44
	NP2-J01	Yellow Lid One Hole Enclosure 65x65	R81.34
	NP2-J174	Emergency Stop 65 x 65 Yellow Enclosure	R172.67
	NP2-J10J	Push Button Enclosure	R123.52
			

## Push Buttons (IP65)



Pushbutton Non-illuminated

Product Code	Item Description	Price
NP8-10BN/1	Pushbutton Non-illuminated White 1NO	R119.06
NP8-10BN/2	Pushbutton Non-illuminated Black 1NO	R119.06
NP8-10BN/3	Pushbutton Non-illuminated Green 1NO	R119.06
NP8-10BN/5	Pushbutton Non-illuminated Yellow 1NO	R119.06
NP8-10BN/6	Pushbutton Non-illuminated Blue 1NO	R119.06
NP8-01BN/4	Pushbutton Non-illuminated Red 1NC	R119.06



Pushbutton Illuminated

NP8-10BND/3	Pushbutton illuminated Green 1NO 110V-230V	R245.57
NP8-10BND/5	Pushbutton illuminated Yellow 1NO 110V-230V	R244.41
NP8-10BND/6	Pushbutton illuminated Blue 1NO 110V-230V	R245.57
NP8-01BND/4	Pushbutton illuminated Red 1NC 110V-230V	R245.57



Emergency Stop Twist Release

NP8-01ZS/14	Emergency Stop Red 40mm Twist Release	R150.13
NP8-01ZS/24	Emergency Stop Red 60mm Twist Release	R145.40



Pushbutton Double-headed

NP8-11S	Pushbutton Red and Green 1NO+1NC	R162.82
NP8-11SD	Pushbutton Red and Green illuminated 110V-230V 1NO+1NC	R309.20



Selector Switches

NP8-10X/212	Selector Switch 2 Position Stay Put 1NO	R134.66
NP8-10X/222	Selector Switch 2 Position Spring Return 1NO	R134.66
NP8-20X/312	Selector Switch 3 Position Stay Put 2NO	R198.32
NP8-20X/332	Selector Switch 3 Position Spring Return 2NO	R198.32



NP8 Accessories

NP8-CONTACT NO	Auxiliary Contact Block NO	R66.43
NP8-CONTACT NC	Auxiliary Contact Block NC	R66.43
NP8 BASE	Spare Base NP8	R14.98
WARNING	Yellow Emergency Label 22mm	R8.96



## VSD and Soft Starters

### VSD





Product Code	Item Description	Price
NVF3M-0.75/TS4	0.75KW Variable Speed Drive 380V	R9 546.19
NVF2G-1.5/TS4	1.5KW Variable Speed Drive 380V	R13 788.50
NVF2G-2.2/TS4	2.2KW Variable Speed Drive 380V	R13 788.50
NVF2G-3.7/TS4	3.7KW Variable Speed Drive 380V	R15 885.54
NVF2G-5.5/TS4	5.5KW Variable Speed Drive 380V	R18 113.41
NVF2G-7.5/TS4	7.5KW Variable Speed Drive 380V	R18 616.57
NVF2G-11/TS4	11KW Variable Speed Drive 380V	R28 671.49
NVF2G-15/TS4	15KW Variable Speed Drive 380V	R33 897.26
NVF2G-18.5/TS4	18.5KW Variable Speed Drive 380V	R34 555.93
NVF2G-22/TS4	22KW Variable Speed Drive 380V	R63 348.51
NVF2G-30/TS4	30kW Variable Speed Drive 380V	R63 606.59
NVF2G-37/TS4	37kW Variable Speed Drive 380V	R63 606.59
NVF2G-45/TS4	45kW Variable Speed Drive 380V	R72 813.85
NVF2G-55/TS4	55KW Variable Speed Drive 380V	R74 806.54
NVF2G-75/TS4	75KW Variable Speed Drive 380V	R96 396.01
NVF2G-90/TS4	90kW Variable Speed Drive 380V	R110 841.30
NVF2G-110/TS4	110kW Variable Speed Drive 380V	R163 345.19
NVF2G-132/TS4	132kW Variable Speed Drive 380V	R178 253.64
NVF2G-160/TS4	160kW Variable Speed Drive 380V	R252 796.03
NVF2G-200/TS4	200kW Variable Speed Drive 380V	R262 518.98
EXT.CAB NVF2G(10M)	10m NVF2G Extension Cable & Support Plate	R1 124.03
EXT.CAB NVF2G(6M)	6m NVF2G Extension Cable & Support Plate	R760.26
EXT.CAB NVF2G(4M)	4m NVF2G Extension Cable & Support Plate	R529.96
EXT.CABLE NVF2G(2M)	2m NVF2G Extension Cable & Support Plate	R375.64

Soft Starters	Product Code	Item Description	Price
	NJR2-7.5D	7.5kW Soft Starter 380V	R13 867.18
	NJR2-11D	11kW Soft Starter 380V	R13 867.18
	NJR2-15D	15kW Soft Starter 380V	R13 867.18
	NJR2-18.5D	18.5kW Soft Starter 380V	R14 198.50
	NJR2-22D	22kW Soft Starter 380V	R14 316.41
	NJR2-30D	30kW Soft Starter 380V	R16 420.56
	NJR2-37D	37kW Soft Starter 380V	R20 007.10
	NJR2-45D	45kW Soft Starter 380V	R20 007.10
	NJR2-55D	55kW Soft Starter 380V	R26 552.59
	NJR2-75D	75kW Soft Starter 380V	R36 806.98
	NJR2-90D	90kW Soft Starter 380V	R39 248.89
	NJR2-110D	110kW Soft Starter 380V	R39 250.09
	NJR2-132D	132kW Soft Starter 380V	R40 678.98



## Isolators

Large Frame Isolators	Product Code	Item Description	Price
	NXHM-125/3-125A	3 Pole Large Frame Isolator 125A	R1 434.37
	NXHM-160/3-160A	3 Pole Large Frame Isolator 160A	R2 048.83
	NXHM-250/3-250A	3 Pole Large Frame Isolator 250A	R2 163.71
	NXHM-400/3-400A	3 Pole Large Frame Isolator 400A	R5 656.07
	NXHM-630/3-630A	3 Pole Large Frame Isolator 630A	R8 778.48

Din Rail Isolators	Product Code	Item Description	Price
	NH2-125-1P-32A	Isolator 1P 32A Din Rail	R66.17
	NH2-125-1P-63A	Isolator 1P 63A Din Rail	R76.12
	NH2-125-1P-100A	Isolator 1P 100A Din Rail	R108.43
	NH2-125-1P-125A	Isolator 1P 125A Din Rail	R115.73
	NH2-125-2P-32A	Isolator 2P 32A Din Rail	R132.33
	NH2-125-2P-63A	Isolator 2P 63A Din Rail	R145.59
	NH2-125-2P-100A	Isolator 2P 100A Din Rail	R214.34
	NH2-125-2P-125A	Isolator 2P 125A Din Rail	R222.77

	NH2-125-3P-32A	Isolator 3P 32A Din Rail	R194.38
	NH2-125-3P-63A	Isolator 3P 63A Din Rail	R213.41
	NH2-125-3P-100A	Isolator 3P 100A Din Rail	R307.82
	NH2-125-3P-125A	Isolator 3P 125A Din Rail	R323.21
	NH2-125-4P-32A	Isolator 4P 32A Din Rail	R260.56
	NH2-125-4P-63A	Isolator 4P 63A Din Rail	R283.73
	NH2-125-4P-100A	Isolator 4P 100A Din Rail	R419.73
	NH2-125-4P-125A	Isolator 4P 125A Din Rail	R440.72

Weatherproof Isolators	Product Code	Item Description	Price
	UKF2-20	Weatherproof Isolator 2P 20A/440V	R290.70
	UKF2-35	Weatherproof Isolator 2P 35A/440V	R290.70
	UKF2-63	Weatherproof Isolator 2P 63A/440V	R290.70
	UKF3-20	Weatherproof Isolator 3P 20A/440V	R307.22
	UKF3-35	Weatherproof Isolator 3P 35A/440V	R307.22
	UKF3-63	Weatherproof Isolator 3P 63A/440V	R307.22
	UKF4-35	Weatherproof Isolator 4P 35A/440V	R344.05
	UKF4-63	Weatherproof Isolator 4P 63A/440V	R344.05

JOHNN

Rotary Isolators	Product Code	Item Description	Price
	UKP-316	Rotary Isolator 3P 16A IP65	R383.30
	UKP-320	Rotary Isolator 3P 20A IP65	R384.77
	UKP-325	Rotary Isolator 3P 25A IP65	R441.29
	UKP-332	Rotary Isolator 3P 32A IP65	R617.60
	UKP-363	Rotary Isolator 3P 63A IP65	R845.22
	UKP-3100	Rotary Isolator 3P 100A IP65	R2 021.39
	UKP-420	Rotary Isolator 4P 20A IP65	R423.03
	UKP-432	Rotary Isolator 4P 32A IP65	R791.26
	UKP-463	Rotary Isolator 4P 63A IP65	R926.16
	UKP-4100	Rotary Isolator 4P 100A IP65	R2 197.99



JOHNN

Isolator with Extension Handles	Product Code	Item Description	Price
	NH40-125/3W	125A 3P Isolator with Extension Handle	R2 028.11
	NH40-160/3W	160A 3P Isolator with Extension Handle	R2 183.38
	NH40-200/3W	200A 3P Isolator with Extension Handle	R3 276.02
	NH40-250/3W	250A 3P Isolator with Extension Handle	R3 353.66
	NH40-315/3W	315A 3P Isolator with Extension Handle	R4 892.90
	NH40-400/3W	400A 3P Isolator with Extension Handle	R4 974.06
	NH40-630/3W	630A 3P Isolator with Extension Handle	R6 848.87
	NH40-1000/3W	1000A 3P Isolator with Extension Handle	R13 209.74
	NH40-1250/3W	1250A 3P Isolator with Extension Handle	R14 863.32
	NH40-1600/3W	1600A 3P Isolator with Extension Handle	R17 939.06

	NH40-125/4W	125A 4P Isolator with Extension Handle	R3 119.79
	NH40-160/4W	160A 4P Isolator with Extension Handle	R3 276.02
	NH40-200/4W	200A 4P Isolator with Extension Handle	R4 133.84
	NH40-250/4W	250A 4P Isolator with Extension Handle	R4 290.07
	NH40-315/4W	315A 4P Isolator with Extension Handle	R6 359.87
	NH40-400/4W	400A 4P Isolator with Extension Handle	R6 604.37
	NH40-630/4W	630A 4P Isolator with Extension Handle	R8 316.83
	NH40-1000/4W	1000A 4P Isolator with Extension Handle	R17 123.65
	NH40-1250/4W	1250A 4P Isolator with Extension Handle	R20 501.49
	NH40-1600/4W	1600A 4P Isolator with Extension Handle	R22 551.64





# Changeover Switches

Changeover Switches	Product Code	Item Description	Price
	NXZB-63H/4C 63A	63A 4P Automatic Changeover Switch	R7 007.22
	NXZ-125/4A 80A	80A 4P Automatic Changeover Switch	R12 004.82
	NXZ-125/4A 100A	100A 4P Automatic Changeover Switch	R12 004.82
	NXZ-125/4A 125A	125A 4P Automatic Changeover Switch	R12 004.82
	NXZ-250/4A 160A	160A 4P Automatic Changeover Switch	R20 067.48
	NXZ-250/4A 200A	200A 4P Automatic Changeover Switch	R20 067.48
	NXZ-250/4A 250A	250A 4P Automatic Changeover Switch	R20 067.48
	NXZ-630/4A 315A	315A 4P Automatic Changeover Switch	R36 281.82
	NXZ-630/4A 400A	400A 4P Automatic Changeover Switch	R36 281.82
	NH40-1000/4SZ	1000A 4P Automatic Changeover Switch	R97 204.48
	NH40-1250/4SZ	1250A 4P Automatic Changeover Switch	R106 551.05

Changeover Switches	Product Code	Item Description	Price
	NH40-160/3CSW	160A 3P Changeover Switch with Extension Handle	R4 757.80
	NH40-200/3CSW	200A 3P Changeover Switch with Extension Handle	R5 693.27
	NH40-250/3CSW	250A 3P Changeover Switch with Extension Handle	R5 771.85
	NH40-315/3CSW	315A 3P Changeover Switch with Extension Handle	R11 252.77
	NH40-400/3CSW	400A 3P Changeover Switch with Extension Handle	R11 578.43
	NH40-630/3CSW	630A 3P Changeover Switch with Extension Handle	R13 698.72
	NH40-1000/3CSW	1000A 3P Changeover Switch with Extension Handle	R30 752.23
	NH40-1250/3CSW	1250A 3P Changeover Switch with Extension Handle	R32 802.39

	NH40-160/4CSW	160A 4P Changeover Switch with Extension Handle	R5 771.85
	NH40-200/4CSW	200A 4P Changeover Switch with Extension Handle	R6 785.90
	NH40-250/4CSW	250A 4P Changeover Switch with Extension Handle	R6 941.18
	NH40-315/4CSW	315A 4P Changeover Switch with Extension Handle	R14 187.72
	NH40-400/4CSW	400A 4P Changeover Switch with Extension Handle	R14 676.71
	NH40-630/4CSW	630A 4P Changeover Switch with Extension Handle	R18 590.63
	NH40-1000/4CSW	1000A 4P Changeover Switch with Extension Handle	R38 012.27
	NH40-1250/4CSW	1250A 4P Changeover Switch with Extension Handle	R41 088.01

	COS-2/25	Enclosed Changeover Switch 25A 2P IP65	R1 124.14
	COS-2/40	Enclosed Changeover Switch 40A 2P IP65	R1 124.14
	COS-3/25	Enclosed Changeover Switch 25A 3P IP65	R1 155.36
	COS-3/40	Enclosed Changeover Switch 40A 3P IP65	R1 155.36

	JN219G40A	Changeover Switch 40A 2P Din-Rail	R423.50
	JN219G63A	Changeover Switch 63A 2P Din-Rail	R605.71
	JN419G63A	Changeover Switch 63A 4P Din-Rail	R1 057.14





# Relays





Perfect  
reliable choice

Time Relays	Product Code	Item Description	Price
	NTE8-10B-DELO	Time Delay On Timer 1-10 Sec AC230V	R295.01
	NTE8-120B-DELO	Time Delay On Timer 12-120 Sec AC230V	R299.54
	NTE8-480B-DELO	Time Delay On Timer 48-480 Sec AC230V	R318.74
	NTE8-M1-DELO	Time Delay On Timer 1 Sec-10 Day AC230V	R552.66
	NTE8-10A-DELOFF	Time Delay Off Timer 1-10 Sec AC230V	R295.01
	NTE8-120A-DELOFF	Time Delay Off Timer 12-120 Sec AC230V	R299.54
	NTE8-480A-DELOFF	Time Delay Off Timer 48-480 Sec AC230V	R318.74
	NTE8-Y AC230V	Star-Delta Relay 3s-30s AC230	R546.08
	NTE8-Y AC380V	Star-Delta Relay 3s-30s AC380	R546.08
Phase Failure Relays	Product Code	Item Description	Price
	NJYB1-AC380V	Phase Failure Relay AC380V Din Rail (PF, PS)	R1 044.34
	NJYB3-8-AC220V	Phase Failure Relay AC220V Din Rail (PF, PS, OV, UV)	R885.53
	NJYB3-8-AC380V	Phase Failure Relay AC380V Din Rail (PF, PS, OV, UV)	R895.94
	NJYB3-3-AC380V	Phase Failure Relay AC380V Din Rail (PF, PS, UV)	R885.53
	XJ3-D-380V	Phase Failure Relay AC380V (PF, PS, OV, UV)	R819.17

Power Relays	Product Code	Item Description	Price
	JZX-22FD-2Z-24V	Miniature Power Relay 8 Pin 24VAC+LED Indicator	R113.67
	JZX-22FD-2Z-110V	Miniature Power Relay 8 Pin 110VAC+LED Indicator	R113.67
	JZX-22FD-2Z-220V	Miniature Power Relay 8 Pin 220VAC+LED Indicator	R113.67
	JZX-22FD-2Z-12DC	Miniature Power Relay 8 Pin 12VDC+LED Indicator	R113.67
	JZX-22FD-2Z-24DC	Miniature Power Relay 8 Pin 24VDC+LED Indicator	R113.67
	JZX-22FD-3Z-24V	Miniature Power Relay 11 Pin 24VAC+LED Indicator	R121.79
	JZX-22FD-3Z-110V	Miniature Power Relay 11 Pin 110VAC+LED Indicator	R121.79
	JZX-22FD-3Z-220V	Miniature Power Relay 11 Pin 220VAC+LED Indicator	R121.79
	JZX-22FD-3Z-12DC	Miniature Power Relay 11 Pin 12VDC+LED Indicator	R121.79
	JZX-22FD-3Z-24DC	Miniature Power Relay 11 Pin 24VDC+LED Indicator	R121.79
	JZX-22FD-4Z-24V	Miniature Power Relay 14 Pin 24VAC+LED Indicator	R135.96
	JZX-22FD-4Z-110V	Miniature Power Relay 14 Pin 110VAC+LED Indicator	R135.96
	JZX-22FD-4Z-220V	Miniature Power Relay 14 Pin 220VAC+LED Indicator	R135.96
	JZX-22FD-4Z-24VDC	Miniature Power Relay 14 Pin 24VDC+LED Indicator	R135.96
	JQX-10F-2Z-12V	Miniature Power Relay 8 Pin 12VAC	R140.04
	JQX-10F-2Z-24V	Miniature Power Relay 8 Pin 24VAC	R140.04
	JQX-10F-2Z-110V	Miniature Power Relay 8 Pin 110VAC	R153.26
	JQX-10F-2Z-220V	Miniature Power Relay 8 Pin 220VAC	R143.08
	JQX-10F-2Z-12VDC	Miniature Power Relay 8 Pin 12VDC	R140.04
	JQX-10F-2Z-24VDC	Miniature Power Relay 8 Pin 24VDC	R147.16
	JQX-10F-3Z-12V	Miniature Power Relay 11 Pin 12VAC	R172.47
	JQX-10F-3Z-24V	Miniature Power Relay 11 Pin 24VAC	R172.47
	JQX-10F-3Z-110V	Miniature Power Relay 11 Pin 110VAC	R189.79
	JQX-10F-3Z-220V	Miniature Power Relay 11 Pin 220VAC	R189.79
	JQX-10F-3Z-380V	Miniature Power Relay 11 Pin 380VAC	R216.16
	JQX-10F-3Z-12VDC	Miniature Power Relay 11 Pin 12VDC	R182.68
	JQX-10F-3Z-24VDC	Miniature Power Relay 11 Pin 24VDC	R182.68
	JQX-10F-3Z-220VDC	Miniature Power Relay 11 Pin 220VDC	R182.68



Voltage Protection Relays	Product Code	Item Description	Price
	OUVR-1/80A-1P+N-BE	Over Under Voltage Relay 80A 1P+N Bottom Entry	R526.82
	OUVR-1/80A-3P+N-BE	Over Under Voltage Relay 80A 3P+N Bottom Entry	R1 627.35

Accessories	Product Code	Item Description	Price
	RB-CZY08A-E	8 Pin Flat Power Relay Base Finger Protection	R56.07
	RB-CZY08B-01	8 Pin Flat Power Relay Base	R36.51
	RB-CZY11B	11 Pin Flat Power Relay Base	R39.61
	RB-CZY14B	14 Pin Flat Power Relay Base	R54.78
	RB-CZY14B-E	14 Pin Flat Power Relay Base Finger Protection	R70.09
	RB-CZF08A	8 Pin Round Power Relay Base	R26.96
	RB-CZF11A	11Pin Round Power Relay Base	R35.42
	RB-CZS08C	8 Pin Round Time Relay Base	R40.60





## Current Transformers



Stable and reliable for power conversion

CT	Product Code	Item Description	Price
	CTI-30-50/5A	30mm Current Transformer 50/5A	R274.46
	CTI-30-60/5A	30mm Current Transformer 60/5A	R274.46
	CTI-30-75/5A	30mm Current Transformer 75/5A	R274.46
	CTI-30-100/5A	30mm Current Transformer 100/5A	R280.23
	CTI-30-150/5A	30mm Current Transformer 150/5A	R260.94
	CTI-30-200/5A	30mm Current Transformer 200/5A	R260.94
	CTI-30-250/5A	30mm Current Transformer 250/5A	R260.94
	CTI-40-300/5A	40mm Current Transformer 300/5A	R338.24
	CTI-50-400/5A	50mm Current Transformer 400/5A	R374.01
		CTI-50-500/5A	50mm Current Transformer 500/5A
CTI-50-600/5A		50mm Current Transformer 600/5A	R382.66
CTI-80-800/5A		80mm Current Transformer 800/5A	R608.83
CTI-80-1000/5A		80mm Current Transformer 1000/5A	R608.83
CTI-80-1500/5A		80mm Current Transformer 1500/5A	R782.74
CTI-100-1000/5A		100mm Current Transformer 1000/5A	R726.74
CTI-100-1500/5A		100mm Current Transformer 1500/5A	R837.87
CTI-120-2500/5A		120mm Current Transformer 2500/5A	R1 232.13
CTI-120-3000/5A	120mm Current Transformer 3000/5A	R1 327.80	



## Voltage Transformers

VT	Product Code	Item Description	Price
	NDK-25VA-230V/24V	Primary 230V Secondary 24V Output	R509.61
	NDK-50VA-12V	Primary 440V+230V Secondary 12V Output	R639.87
	NDK-50VA-230V/24V	Primary 230V Secondary 24V Output	R639.87
	NDK-50VA-24V	Primary 440V+230V Secondary 24V Output	R639.87
	NDK-50VA-36V	Primary 440V+230V Secondary 36V Output	R639.87
	NDK-50VA-110V	Primary 440V+230V Secondary 110V Output	R639.87
	NDK-50VA-220V	Primary 440V+230V Secondary 220V Output	R639.87
	NDK-100VA-12V	Primary 440V+230V Secondary 12V Output	R885.34
	NDK-100VA-24V	Primary 440V+230V Secondary 24V Output	R885.34
	NDK-100VA-36V	Primary 440V+230V Secondary 36V Output	R885.34
	NDK-100VA-110V	Primary 440V+230V Secondary 110V Output	R885.34
	NDK-100VA-220V	Primary 440V+230V Secondary 220V Output	R885.34
	NDK-150VA-12V	Primary 440V+230V Secondary 12V Output	R1 060.25
	NDK-150VA-24V	Primary 440V+230V Secondary 24V Output	R1 060.25
	NDK-150VA-36V	Primary 440V+230V Secondary 36V Output	R1 060.25
	NDK-150VA-48V	Primary 440V+230V Secondary 48V Output	R1 060.25
	NDK-150VA-110V	Primary 440V+230V Secondary 110V Output	R1 060.25
	NDK-150VA-220V	Primary 440V+230V Secondary 220V Output	R1 060.25
	NDK-200VA-12V	Primary 440V+230V Secondary 12V Output	R1 840.66



VT	Product Code	Item Description	Price
	NDK-200VA-24V	Primary 440V+230V Secondary 24V Output	R1 840.66
	NDK-200VA-36V	Primary 440V+230V Secondary 36V Output	R1 840.66
	NDK-200VA-110V	Primary 440V+230V Secondary 110V Output	R1 840.66
	NDK-200VA-220V	Primary 440V+230V Secondary 220V Output	R1 840.66
	NDK-300VA-12V	Primary 440V+230V Secondary 12V Output	R2 053.04
	NDK-300VA-24V	Primary 440V+230V Secondary 24V Output	R2 053.04
	NDK-300VA-36V	Primary 440V+230V Secondary 36V Output	R2 053.04
	NDK-300VA-110V	Primary 440V+230V Secondary 110V Output	R2 053.04
	NDK-300VA-220V	Primary 440V+230V Secondary 220V Output	R2 053.04
	NDK-500VA-12V	Primary 440V+230V Secondary 12V Output	R2 539.13
	NDK-500VA-24V	Primary 440V+230V Secondary 24V Output	R2 539.13
	NDK-500VA-36V	Primary 440V+230V Secondary 36V Output	R2 539.13
	NDK-500VA-110V	Primary 440V+230V Secondary 110V Output	R2 539.13
	NDK-500VA-220V	Primary 440V+230V Secondary 220V Output	R2 539.13
	NDK-1000VA-12V	Primary 440V+230V Secondary 12V Output	R4 863.26
	NDK-1000VA-24V	Primary 440V+230V Secondary 24V Output	R4 863.26
	NDK-1000VA-36V	Primary 440V+230V Secondary 36V Output	R4 863.26
	NDK-1000VA-110V	Primary 440V+230V Secondary 110V Output	R4 863.26
	NDK-1000VA-220V	Primary 440V+230V Secondary 220V Output	R4 863.26



## AVR

AVR	Product Code	Item Description	Price
	TDGC2-2-8A-240V	2kVA Voltage Regulator 8A 240V	R3 890.07
	TDGC2-3-12A-240V	3kVA Voltage Regulator 12A 240V	R4 879.33



# Travel Switches

# Travel Switches

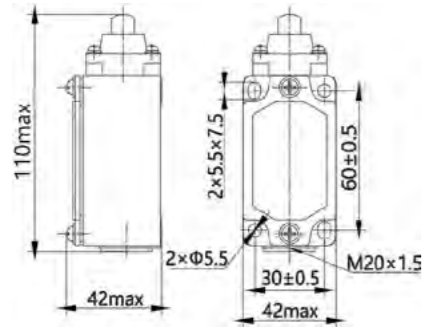

YBLX-K3 Dimensions



YBLX-K3/20S-Z  
Travel Switch Plunger Type R216.71



YBLX-K3/20S-L  
Travel Switch Plunger With Roller Type R225.61



YBLX-ME/8104  
Travel Switch Roller Rotating Arm R236.51



YBLX-ME/8107  
Travel Switch Adjustable Rotating Rod R268.93

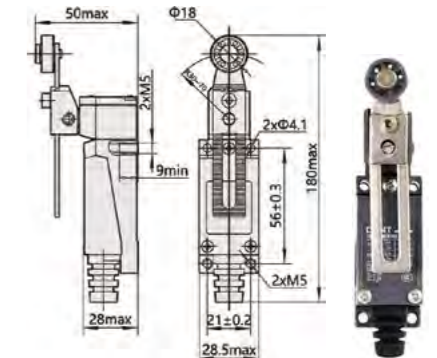

YBLX-ME/8108  
Travel Switch Adjustable Roller Rotating Rod R256.38



YBLX-K3/20S-J  
Travel Switch Adjust Metal Rocker Type R252.33



YBLX-K3/20S-D  
Travel Switch Flexible Rocker Type R279.00



YBLX-K3/20S-B  
Travel Switch Rotating Arm With Roller R279.00



YBLX-ME/8111  
Travel Switch Direct Pressure Plunger R200.13



YBLX-ME/8112  
Travel Switch Direct Pressure Plunger HR R213.93



YBLX-ME/8122  
Travel Switch Direct Pressure Plunger VR R213.51



YBLX-K3/20S-T  
Travel Switch Adjust Rotating Arm R288.99



YBLX-K3/20S-H  
Travel Switch Fork Type 2 Rollers R288.99

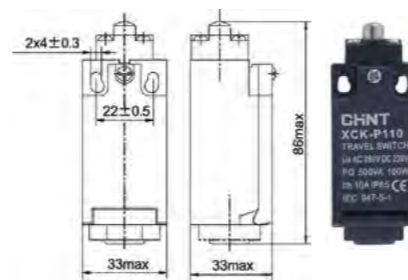

YBLX-CK-P110  
Travel Switch YBLX-CK/P110 R349.24



YBLX-ME/8166  
Travel Switch Universal Type Plastic Tip R209.95



YBLX-ME/8169  
Travel Switch Universal Type Plastic Tip R198.71



YBLX-ME/8101  
Travel Switch Universal Coiled Spring R216.02

# Travel Switches



**YBLXW-5/11N2**  
Micro Switch 5/11N2 R67.81



**YBLXW-5/11Z**  
Micro Switch 5/11Z R71.14



**YBLXW-5/11D1**  
Micro Switch 5/11D1 R74.48



**YBLXW-5/11N1**  
Micro Switch 5/11N1 R74.48



**YBLXW-5/11G2**  
Micro Switch 5/11G2 R76.71



**YBLXW-5/11G3**  
Micro Switch 5/11G3 R80.04



**YBLXW-5/11Q1**  
Micro Switch 5/11Q1 R115.62



**YBLXW-5/11Q2**  
Micro Switch 5/11Q2 R115.62



**YBLXW-5/11-M**  
Micro Switch 5/11M R121.19

# Float Switches

## Float Switches



Product Code	Item Description	Price
FS-2-5M	Float Switch 5 Meter	R272.99
FS-2-10M	Float Switch 10 Meter	R435.31

# Terminals

## Terminals



Product Code	Item Description	Price
JCUK-5JD	Earth Connection Terminal 5mm	R59.29
JCUK-6JD	Earth Connection Terminal 6mm	R80.02
JCUK-10JD	Earth Connection Terminal 10mm	R108.02
JCUK-16JD	Earth Connection Terminal 16mm	R197.31
JCUK-35JD	Earth Connection Terminal 35mm	R311.92



JCUK-5N	Terminal Blocks JCUK-5N (UK5N-1 with plate)	R31.14
---------	---	--------

Terminals	Product Code	Item Description	Price
	JXB-4/1	Connection Terminal 4/1	R21.15
	JXB-10/1	Connection Terminal 10/1	R52.29
	JXB-2.5/1	Connection Terminal 2.5/1	R11.91
	JXB-6/1	Connection Terminal 6/1	R28.88
	JXB-16/1	Connection Terminal 16/1	R52.29
	JXB-35/1	Connection Terminal 35/1	R66.13
	JXB-70/1	Connection Terminal 70/1	R288.56

AP-2.5-JXB	JXB Barrier 2.5mm	R7.71
AP-4-10-JXB	JXB Barrier 4-10mm	R5.29
AP-16-JXB	JXB Barrier 16mm	R7.28
AP-35-JXB	JXB Barrier 35mm	R10.13
AP-70-JXB	JXB Barrier 70mm	R36.58
EW35	Din End Stop for JXB (EW35)	R6.71



TB-1503	Terminal Block 3 way 15A	R15.48
TB-1506	Terminal Block 6 Way 15A	R27.86
TB-2503	Terminal Block 3 Way 25A	R24.57
TB-2506	Terminal Block 6 Way 25A	R46.71
TB-2512	Terminal Block 12 Way 25A	R84.27
TB-6003	Terminal Block 3 Way 60A	R130.89
TB-10003	Terminal Block 3 Way 100A	R207.01



TC-1503	Terminal Block 3 Way 150A	R211.03
TC-2003	Terminal Block 3 Way 200A	R250.68
TC-3003	Terminal Block 3 Way 300A	R516.50



## Fuses

Fuses	Product Code	Item Description	Price
	RT28-32-02A	Fuse 2A AC380/500V gG/gL	R10.25
	RT28-32-04A	Fuse 4A AC380/500V gG/gL	R10.25
	RT28-32-06A	Fuse 6A AC380/500V gG/gL	R10.25
	RT28-32-10A	Fuse 10A AC380/500V gG/gL	R10.25
	RT28-32-16A	Fuse 16A AC380/500V gG/gL	R10.25
	RT28-32-20A	Fuse 20A AC380/500V gG/gL	R10.25
	RT28-32-25A	Fuse 25A AC380/500V gG/gL	R10.25
	RT28-32-32A	Fuse 32A AC380/500V gG/gL	R10.25
	FUSE-HOLDER-1P	Fuse Holder 1 Pole for RT28-32	R51.80
	FUSE-HOLDER-2P	Fuse Holder 2 Pole for RT28-32	R132.91
	FUSE-HOLDER-3P	Fuse Holder 3 Pole for RT28-32	R199.89

RT28-32

Fuse Holder



Fuse Base for RT36-1

RT36-1



RT36-1-200A	Fuse 200A AC500V/DC440V gG/gL	R206.06
RT36-1 250A	Fuse 250A AC500V/DC440V gG/gL	R206.06
Fuse base-RT36-1	Fuse Base for RT36-1	R231.75

## Meters

Meters	Product Code	Item Description	Price
	DDSU666 1P 5(80)A	Single Phase Din-Rail Meter 5(80)A 230V	R1 879.88
	DTSU666 3P 5(80)A	Three Phase Four Wire Meter 5(80)A 3x230/400V	R3 481.80
	NP72-V-300V	Volt Meter 300v 72x72mm	R438.73
	NP72-V-500V	Volt Meter 500v 72x72mm	R438.73
	ZTY0123A	Digital Multi-Meter	R751.13
	ZTY0125A	Industrial Digital Multi-Meter	R 1 543.98
	ZTY0225A	Digital Clamp Meter AC/DC600V	R1 938.74
	N266	Digital Clamp Meter AC750V/DC1000V	R1 335.34

## Switches and Sockets

Switches and Sockets	Product Code	Item Description	Price
	NEW3-N00100	1 Lever 1 Way Switch 16A 2x4	R49.51
	NEW3-N00200	1 Lever 2 Way Switch 16A 2x4	R54.84
	NEW3-N00300	2 Lever 1 Way Switch 16A 2x4	R58.38
	NEW3-N00400	2 Lever 2 Way Switch 16A 2x4	R67.89
	NEW3-N00500	3 Lever 1 Way Switch 16A 2x4	R74.27
	NEW3-N00700	4 Lever 1 Way Switch 16A 2x4	R83.49
	NEW3-N00900	5 Lever 1 Way Switch 16A 4x4	R129.11
	NEW3-N01100	6 Lever 1 Way Switch 16A 4x4	R141.46
	NEW3-N42940	Single Switched Socket 16A 2x4	R102.57
	NEW3-N42950	Single Switched Socket 16A 4x4	R123.78
	NEW3-N44230	Double Switched Socket 16A 4x4	R160.92
	NEW3-N44330	SA/Euro Combined Switched Socket 16A/10A	R169.76
	NEW3-N00190	Isolator 45A Double Pole 4x4	R212.22
	NEW3-N00160	Isolator 32A Double Pole 2x4	R164.46
	NEW3-N44340	Single Switched Socket 16A; 2 x USB 2100mA	R288.27
	NEW3-N44140	SA/Euro Combined Switched Socket 16A 2x4	R102.57
	NEW3-N44150	SA/3 x Euro Switched Socket 16A 4x4	R164.46
	NEW3-N11800	Six Way Euro Socket 16A 4x4	R181.08
NEW3-N45110	Rotary Dimmer 1 Level 1 Way Switch 2x4	R185.70	
NEW3-N30550	Rotary Dimmer 2x4	R173.30	
NEW3-N95100	Blank Plate 2x4	R34.32	
NEW3-N95110	Blank Plate 4x4	R53.05	

Switches and Sockets	Product Code	Item Description	Price
	K1-CN-K001	1 Lever 1 Way Switch 2x4	R31.07
	K1-CN-K002	2 Lever 1 Way Switch 2x4	R41.07
	K1-CN-K003	3 Lever 1 Way Switch 2x4	R47.14
	K1-CN-K004	4 Lever 1 Way Switch 2x4	R58.93
	K1-CN-K005	5 Lever 1 Way Switch 4x4	R114.29
	K1-CN-K006	6 Lever 1 Way Switch 4x4	R135.71
	K1-CN-K010	1 Lever 2 Way Switch 2x4	R37.50
	K1-CN-K011	2 Lever 2 Way Switch 2x4	R48.21
	K1-CN-K020	Single Switched Socket 16A 2x4	R48.21
	K1-CN-K021	Single Switched Socket 16A 4x4	R62.50
	K1-CN-K022	Double Switched Socket 16A 4x4	R76.79
	K1-CN-K025	Switched Socket 16A + 10A + 2 USB	R196.43
	K1-CN-K026	Isolator 45A 2P 4x4	R121.43
	K1-CN-K030	Dimmer 500W 2x4	R107.14
	K1-CN-K031	1 Lever Switch + Dimmer 2x4	R117.86
	K1-CN-K032	2 Lever Switch + Dimmer 2x4	R121.43
	K1-CN-K034	SA/Euro Combined Switched Socket 16A 4x4	R117.86
	K1-CN-K036	Blank Plate White 2x4	R23.21
	K1-CN-K037	Blank Plate White 4x4	R32.14



Condere

Condere

Condere



## Distribution Boxes and Enclosures

DB and Enclosures	Product Code	Item Description	Price
	DB1-4S	4W Surface Empty Plastic DB	R169.82
	DB1-6S	6W Surface Empty Plastic DB	R213.75
	DB1-8S	8W Surface Empty Plastic DB	R245.85
	DB1-12S	12W Surface Empty Plastic DB	R333.65
	DB1-18S	18W Surface Empty Plastic DB	R527.53
	DB1-4FP	4W Flush Empty Plastic DB	R169.82
	DB1-6FP	6W Flush Empty Plastic DB	R213.75
	DB1-8FP	8W Flush Empty Plastic DB	R245.85
	DB1-12FP	12W Flush Empty Plastic DB	R333.65
	DB1-18FP	18W Flush Empty Plastic DB	R527.53
	DB1-4F	4W Flush Empty Steel DB	R260.63
	DB1-6F	6W Flush Empty Steel DB	R297.69
	DB1-8F	8W Flush Empty Steel DB	R356.95
	DB1-12F	12W Flush Empty Steel DB	R442.59
	DB1-18F	18W Flush Empty Steel DB	R599.15



DB and Enclosures	Product Code	Item Description	Price
	DB1(W)-8SK	8W Populated Surface DB (Plastic Tray DB with 1PCS 2P E/L 63A, 1PCS EBC 2P 63A, 2 PCS EBC1P 20A and 1PCS EBC 1P 10A)	R792.15
	DB1(W)-12SK	12W Populated Surface DB (Plastic Tray DB with 1PCS 2P E/L 63A, 1PCS EBC 2P 63A, 1PCS EBC 1P 32A, 3PCS EBC 1P 20A and 2PCS EBC 1P 10A)	R1 054.72
	DB1W-18SK	18W Populated Surface DB (Plastic Tray DB with 1PCS 2P E/L 63A, 1PCS EBC 2P 63A, 1PCS EBC 1P 32A, 4PCS EBC 1P 20A, 2PCS EBC 1P 10A)	R1 302.74
	DB1(W)-8FK	8W Populated Flush DB (Steel Tray DB with 1PCS 2P E/L 63A, 1PCS EBC 2P 63A, 2 PCS EBC 1P 20A, 1PCS EBC 1P 10A)	R900.33
	DB1(W)-12FK	12W Populated Flush DB (Steel DB with 1PCS 2P E/L 63A, 1PCS EBC 2P 63A, 1PCS EBC 1P 32A, 3PCS EBC 1P 20A and 2PCS EBC 1P 10A)	R1 172.70
	DB1(W)-18FK	18W Populated Flush DB (Steel DB with 1PCS 2P E/L 63A, 1PCS EBC 2P 63A, 1PCS EBC 1P 32A, 4PCS EBC 1P 20A and 2PCS EBC 1P 10A )	R1 378.38
	DB1(W)-12FPK	12W Populated Flush DB (Plastic tray DB with 1PCS 2P E/L 63A, 1PCS EBC 2P 63A, 1PCS EBC 1P 32A, 3PCS EBC 1P 20A and 2PCS EBC 1P 10A)	R1 059.72

DB and Enclosures	Product Code	Item Description	Price
 <b>JOHNN</b>	DB-SH4PN	Waterproof DB IP66 4 Way	R332.68
	DB-SH6PN	Waterproof DB IP66 6 Way	R457.62
	DB-SH9PN	Waterproof DB IP66 9 Way	R555.11
	DB-SH12PN	Waterproof DB IP66 12 Way	R790.49
	DB-SH18PN	Waterproof DB IP66 18 Way	R1 281.62
	DB-SH24PN	Waterproof DB IP66 24 Way	R1 781.30
	DB-SH36PN	Waterproof DB IP66 36 Way	R2 518.57
 <b>JOHNN</b>	OE-25/20/15	Steel Enclosure 250x200x150mm Orange IP65	R877.35
	OE-30/25/15	Steel Enclosure 300x250x150mm Orange IP65	R1 085.92
	OE-30/25/20	Steel Enclosure 300x250x200mm Orange IP65	R1 307.08
	OE-40/30/20	Steel Enclosure 400x300x200mm Orange IP65	R1 720.81
	OE-50/40/25	Steel Enclosure 500x400x250mm Orange IP65	R2 878.97
	OE-60/40/25	Steel Enclosure 600x400x250mm Orange IP65	R3 378.14
	OE-70/50/25	Steel Enclosure 700x500x250mm Orange IP65	R4 177.22
	OE-80/60/25	Steel Enclosure 800x600x250mm Orange IP65	R5 670.05
	OE-100/80/25	Steel Enclosure 1000x800x250mm Orange IP65	R9 595.43
 <b>JOHNN</b>	GWS-80/40	Weatherproof Box 80x40mm (With Knockouts)	R31.46
	GWS-80/80/40	Weatherproof Box 80x80x40mm (With Knockouts)	R44.86
	GWS-100/100/50	Weatherproof Box 100x100x50mm (Without Knockouts)	R61.81
	GWS-150/110/70	Weatherproof Box 150x110x70mm (Without Knockouts)	R116.27
	GWS-240/190/90	Weatherproof Box 240x190x90mm (Without Knockouts)	R341.73
 <b>JOHNN</b>	JB-80/80/40	Weatherproof Box 80x80x40mm	R30.78
	JB-110/110/60	Weatherproof Box 110x110x60mm	R56.84
	JB-155/115/110	Weatherproof Box 155x115x110mm	R126.38
	JB-215/150/110	Weatherproof Box 215x150x110mm	R209.84
	JB-250/200/110	Weatherproof Box 250x200x110mm	R312.84
	JB-255/200/160	Weatherproof Box 255x200x160mm	R425.92
	JB-310/230/145	Weatherproof Box 310x230x145mm	R537.11







# Photovoltaic Devices

PV DC Circuit Breakers	Product Code	Item Description	Price
 <b>NOARK</b>	Ex9BP-JX 1P K10	PV DC Circuit Breaker 10A 1P 250V	R337.77
	Ex9BP-JX 1P K16	PV DC Circuit Breaker 16A 1P 250V	R337.77
	Ex9BP-JX 1P K20	PV DC Circuit Breaker 20A 1P 250V	R337.77
	Ex9BP-JX 1P K25	PV DC Circuit Breaker 25A 1P 250V	R347.15
	Ex9BP-JX 1P K32	PV DC Circuit Breaker 32A 1P 250V	R347.15
	Ex9BP-JX 1P K40	PV DC Circuit Breaker 40A 1P 250V	R347.15
	Ex9BP-JX 1P K63	PV DC Circuit Breaker 63A 1P 250V	R347.15
 <b>NOARK</b>	Ex9BP-JX 2P K10	PV DC Circuit Breaker 10A 2P 500V	R626.76
	Ex9BP-JX 2P K16	PV DC Circuit Breaker 16A 2P 500V	R626.76
	Ex9BP-JX 2P K20	PV DC Circuit Breaker 20A 2P 500V	R626.76
	Ex9BP-JX 2P K25	PV DC Circuit Breaker 25A 2P 500V	R700.70
	Ex9BP-JX 2P K32	PV DC Circuit Breaker 32A 2P 500V	R700.70
	Ex9BP-JX 2P K40	PV DC Circuit Breaker 40A 2P 500V	R700.70
	Ex9BP-JX 2P K63	PV DC Circuit Breaker 63A 2P 500V	R700.70

PV DC Circuit Breakers	Product Code	Item Description	Price
 <b>NOARK</b>	Ex9BP-JX 4P K16	PV DC Circuit Breaker 16A 4P 1000V	R1 218.30
	Ex9BP-JX 4P K20	PV DC Circuit Breaker 20A 4P 1000V	R1 218.30
	Ex9BP-JX 4P K25	PV DC Circuit Breaker 25A 4P 1000V	R1 344.72
	Ex9BP-JX 4P K32	PV DC Circuit Breaker 32A 4P 1000V	R1 344.72
	Ex9BP-JX 4P K40	PV DC Circuit Breaker 40A 4P 1000V	R1 344.72
	Ex9BP-JX 4P K63	PV DC Circuit Breaker 63A 4P 1000V	R1 344.72

	NB1-63DC-1P-C10	PV DC Circuit Breaker 10A 1P DC250V	R230.29
	NB1-63DC-1P-C16	PV DC Circuit Breaker 16A 1P DC250V	R230.29
	NB1-63DC-1P-C20	PV DC Circuit Breaker 20A 1P DC250V	R230.29
	NB1-63DC-1P-C25	PV DC Circuit Breaker 25A 1P DC250V	R230.29
	NB1-63DC-1P-C32	PV DC Circuit Breaker 32A 1P DC250V	R230.29
	NB1-63DC-1P-C40	PV DC Circuit Breaker 40A 1P DC250V	R230.29
	NB1-63DC-1P-C50	PV DC Circuit Breaker 50A 1P DC250V	R248.88
NB1-63DC-1P-C63	PV DC Circuit Breaker 63A 1P DC250V	R248.88	

	NB1-63DC 2P C10	PV DC Circuit Breaker 10A 2P DC500V	R440.67
	NB1-63DC 2P C16	PV DC Circuit Breaker 16A 2P DC500V	R440.67
	NB1-63DC 2P C20	PV DC Circuit Breaker 20A 2P DC500V	R440.67
	NB1-63DC 2P C25	PV DC Circuit Breaker 25A 2P DC500V	R440.67
	NB1-63DC 2P C32	PV DC Circuit Breaker 32A 2P DC500V	R440.67
	NB1-63DC 2P C40	PV DC Circuit Breaker 40A 2P DC500V	R440.67
	NB1-63DC 2P C50	PV DC Circuit Breaker 50A 2P DC500V	R457.86
NB1-63DC 2P C63	PV DC Circuit Breaker 63A 2P DC500V	R457.86	

	NB1-63DC 4P C10	PV DC Circuit Breaker 10A 4P DC1000V	R853.26
	NB1-63DC 4P C16	PV DC Circuit Breaker 16A 4P DC1000V	R853.26
	NB1-63DC 4P C20	PV DC Circuit Breaker 20A 4P DC1000V	R853.26
	NB1-63DC 4P C25	PV DC Circuit Breaker 25A 4P DC1000V	R853.26
	NB1-63DC 4P C32	PV DC Circuit Breaker 32A 4P DC1000V	R853.26
	NB1-63DC 4P C40	PV DC Circuit Breaker 40A 4P DC1000V	R853.26
	NB1-63DC 4P C50	PV DC Circuit Breaker 50A 4P DC1000V	R871.47
NB1-63DC 4P C63	PV DC Circuit Breaker 63A 4P DC1000V	R871.47	

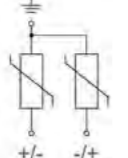
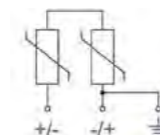
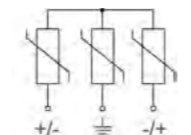
PV DC Surge Arrestors	Product Code	Item Description	Price
	Ex9UEP 20 2P 600	PV DC Surge Arrestor 20KA 2P 600V	R1 448.05
	Ex9UEP 20 2P 1000	PV DC Surge Arrestor 20KA 2P 1000V	R1 490.44
	Ex9UEP 20 3P 1500	PV DC Surge Arrestor 20KA 3P 1500V	R1 595.98
<b>Connection diagram:</b>			
			
Ex9UEP 20 2P 600	Ex9UEP 20 2P 1000	Ex9UEP 20 3P 1500	

NOARK

PV DC Isolator	Product Code	Item Description	Price
	Ex9IP 2P 63A	PV DC Isolator 2P 500V	R514.50
	Ex9IP 4P 63A	PV DC Isolator 4P 1000V	R1 033.35

NOARK

PV Fuses	Product Code	Item Description	Price
	YRPV-30/10A	PV Fuse 10A 1000VDC	R82.26
	YRPV-30/16A	PV Fuse 16A 1000VDC	R82.26
	YRPV-30/20A	PV Fuse 20A 1000VDC	R82.26
	YRPV-30/32A	PV Fuse 32A 1000VDC	R82.26
	YRPV-30 1P Fuse Holder	PV Fuse Holder with indicator	R96.00

JOHNN

Fuse Switch Disconnecter	Product Code	Item Description	Price
	NHR17-160/3	Fuse Switch Disconnecter	R1 490.53
	NHR17-250/3	Fuse Switch Disconnecter	R2 805.71

	RT36-00 63A	Fuse 63A AC500V/DC250V gG/gL(NHR17-160)	R103.79
	RT36-00 80A	Fuse 80A AC500V/DC250V gG/gL(NHR17-160)	R103.79
	RT36-00 100A	Fuse 100A AC500V/DC250V gG/gL(NHR17-160)	R103.79
	RT36-00 125A	Fuse 125A AC500V/DC250V gG/gL(NHR17-160)	R103.79
	RT36-00 160A	Fuse 160A AC500V/DC250V gG/gL(NHR17-160)	R103.79
	RT36-1 200A	Fuse 200A AC500V/DC440V gG/gL(NHR17-250)	R206.06
	RT36-1 250A	Fuse 250A AC500V/DC440V gG/gL(NHR17-250)	R206.06

DC Circuit Breakers	Product Code	Item Description	Price
	NM8NDC-125S TM 125 3P	DC Circuit Breaker 125A 50KA DC750V Adj (0.7-1In)	R4 727.09
	NM8NDC-250S TM 160 3P	DC Circuit Breaker 160A 50KA DC750V Adj (0.7-1In)	R6 044.06
	NM8NDC-250S TM 200 3P	DC Circuit Breaker 200A 50KA DC750V Adj (0.7-1In)	R6 044.06
	NM8NDC-250S TM 250 3P	DC Circuit Breaker 250A 50KA DC750V Adj (0.7-1In)	R6 044.06
	NM8NDC-400S TM 315 3P	DC Circuit Breaker 315A 50KA DC750V Adj (0.7-1In)	R14 485.32
	NM8NDC-400S TM 400 3P	DC Circuit Breaker 400A 50KA DC750V Adj (0.7-1In)	R14 485.32

DC Isolators	Product Code	Item Description	Price
	EDSC100R-EL32R-2	DC Isolator 16A 2P 1000V 1000V IP66	R1 641.65
	EDSC100R-EL32R-4S	DC Isolator 32A 4P 1000V 1000V IP66	R1 869.47

JOHNN

Din Rail DC Isolators	Product Code	Item Description	Price
	EDS1DB/S32/2R	DC Isolator 16A 2P 1200V Din-Rail	R753.82
	EDS1DB/S32/4TR	DC Isolator 32A 4P 1200V Din-Rail	R1 046.98

JOHNN